

# HearthStone III

**SAFETY NOTICE: IF THIS STOVE IS NOT PROPERLY INSTALLED, A HOUSE FIRE MAY RESULT. FOR YOUR SAFETY, FOLLOW THE INSTALLATION DIRECTIONS. CONTACT LOCAL BUILDING OR FIRE OFFICIALS ABOUT RESTRICTIONS AND INSTALLATION INSPECTION IN YOUR AREA.**

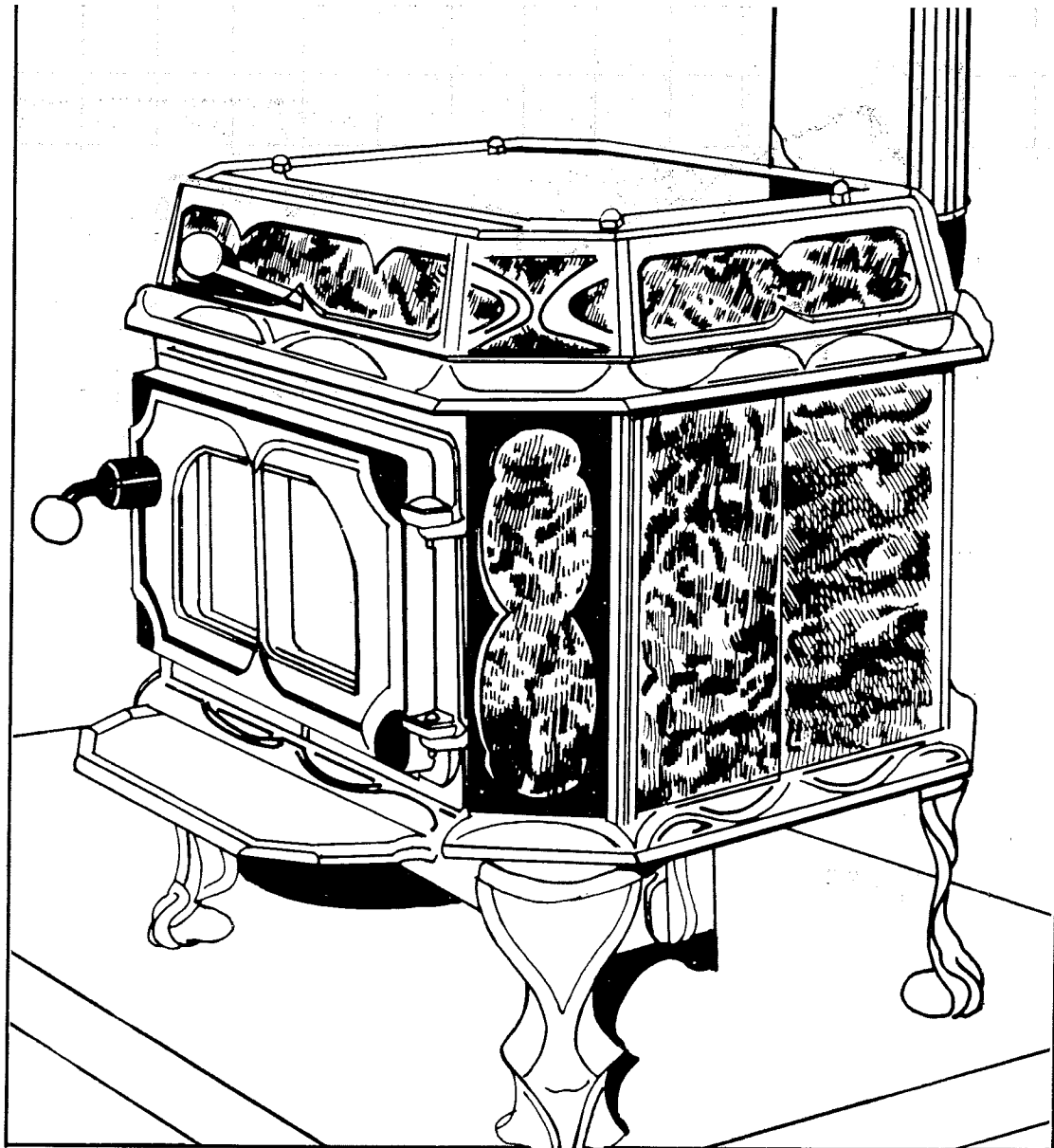

# Owner's Manual



**Y**ou have made an investment in perhaps the finest solid fuel heater available today. To own a HearthStone is to make a statement—a statement of your appreciation and understanding of exceptional quality.

Please read this manual in its entirety. Its purpose is to familiarize you with your stove's safe installation, proper break in, operation, and maintenance. It contains information that will be useful to you now, and in years to come. So keep it handy and refer to it as needed.

The performance of your stove depends on many variables that make your particular installation unique. The sections on operating procedure and general information, therefore, can only serve as useful guidelines rather than hard and fast rules. Moreover, from time to time we make product improvements in between updated press runs of this manual. Should you have any questions, do not hesitate to contact the factory or your dealer for additional information. You have invested in a lifetime product whose warranty is accompanied by a pledge to provide you with assistance as long as you own your stove.

**ABOUT YOUR WARRANTY:** Your new HearthStone Stove has been inspected at the factory prior to shipment, and determined to be free of defects in materials and workmanship.

Should a problem arise with your stove, you are protected by HearthStone's Limited Warranty which covers defective stove parts for a period of three years from the date you receive your stove. For more details, please consult the warranty card which you will find in your stove.

Note that door glass, door gaskets, enameled parts, combustion chamber screens, and furnace cement are not covered by your warranty.

Note also that failure to follow installation instructions and basic operation recommendations presented in this manual will void your warranty, as will negligence, abuse, modification of the stove or the digital electronic air control system (Electronic models), or overfiring, as determined by the HearthStone Corporation or an Authorized HearthStone Dealer.

Lastly, we cannot stress enough the importance of returning to us your Warranty Registration Card, which you will find in your stove. Simply separate it from the portion that states the warranty, which should be kept for your records. Then fill it out and return it to us. This way we will be able to verify and process any warranty claim you may have in the future. In addition, we will have the means to contact you about your stove, should the need ever arise.

**SAFETY NOTICE:** If this stove is not properly installed, a house fire may result. For your safety, follow the installation directions. Contact local building officials about restrictions and installation inspection in your area.

# TABLE OF CONTENTS

1

## PART I: INSTALLATION

3

Section A: Location

3

Section B: Chimneys

3

1. How they work

3

2. Selection

4

Section C: Fireplace Installation

6

Section D: Stovepipe

6

1. Installation

6

2. Stovepipe clearances

6

Section E: Hearths

8

1. Hearth composition

8

2. Hearth size

8

Section F: Clearances

8

## PART II: OPTIONS

9

## PART III: ASSEMBLY

9

## PART IV: OPERATION

10

Section A: The Controls of the Electronic HearthStone III

10

Section B: The Controls of the Manual HearthStone III

10

Section C: Breaking in Your Stove

11

1.The Reasons for Break-in

11

2.The First Fires

11

Section D: Everyday Use

12

1.General Guidelines

12

2.Fireplace Operation

12

3.Overfiring Caution

12

## PART V: MAINTENANCE

13

Section A: During the Heating Season

13

Section B: At Season's End

13

Section C: Stone Finish

13

Section D: Castings

14

Section E: Glass

14

1. Cleaning

14

2. Glass Replacement

14

Section F: Stovepipe and Chimney

14

1. Creosote formation and need for removal

14

2. Inspection

15

## PART VI: SAFETY

16

Section A: General Procedures

16

Section B: Safety Features

16

Section C: Emergency Procedures

16

## PART VII: TROUBLESHOOTING

17

Section A: Smoking

17

Section B: Insufficient Heat

17

## PART VIII: FUEL WOOD INFORMATION

18

## IN CLOSING...

19

## SPECIFICATIONS

20

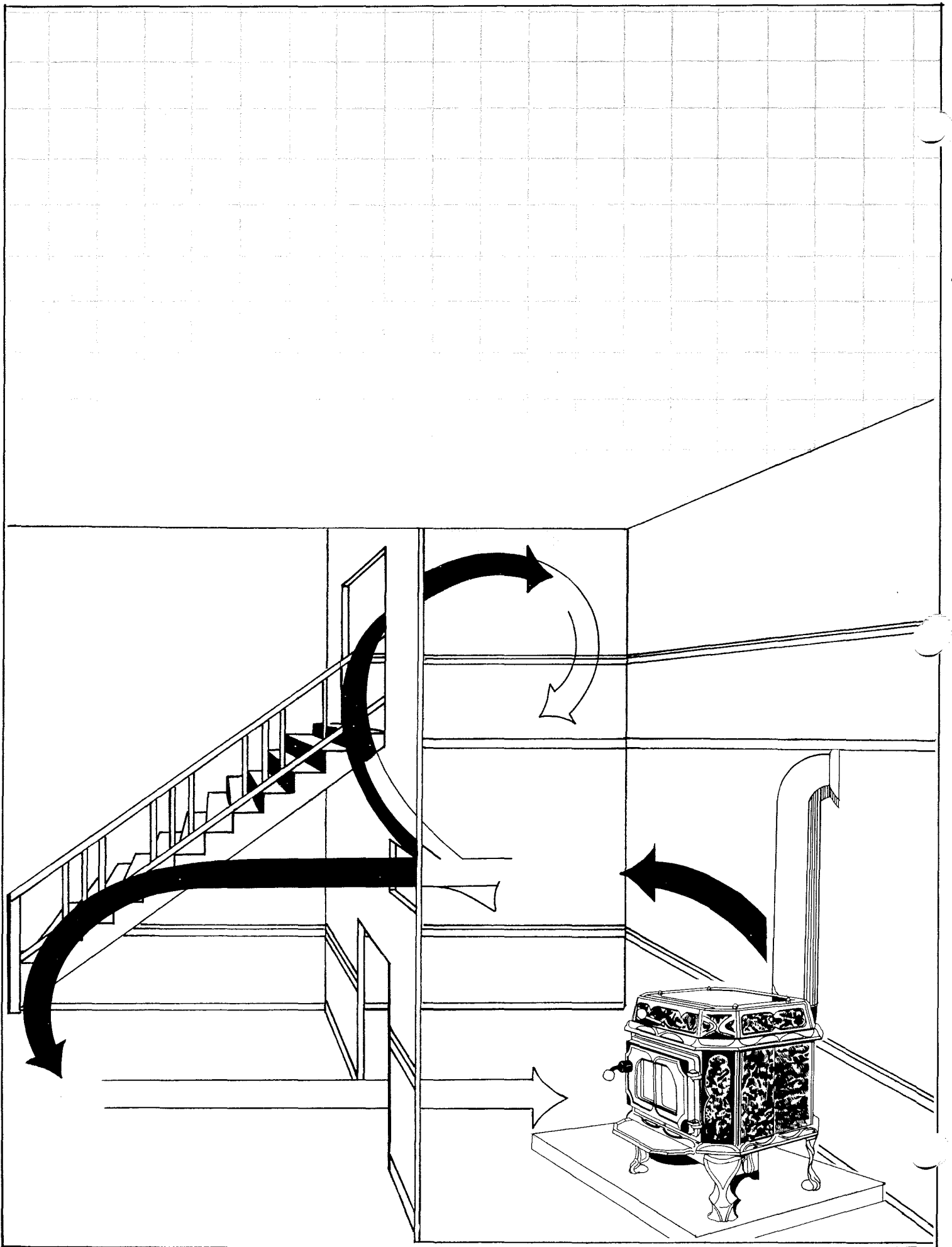

# I

**SAFETY NOTICE: IF THIS STOVE IS NOT PROPERLY INSTALLED, A HOUSE FIRE MAY RESULT. FOR YOUR SAFETY, FOLLOW THE INSTALLATION DIRECTIONS. CONTACT LOCAL BUILDING OR FIRE OFFICIALS ABOUT RESTRICTIONS AND INSTALLATION INSPECTION IN YOUR AREA.**  
**PART I: INSTALLATION**

## SECTION A: LOCATE YOUR STOVE FOR OPTIMUM COMFORT

**T**he useful heat output of your stove is delivered both as infrared radiation and convection. Radiation directly warms the walls, ceiling, furniture — the masses surrounding your stove. Convected heat is also provided as a result of the design of the stove. The heated air in the chamber, between the inner firebox and the outer soapstone walls, rises out through the louvers in the top of the stove. This causes the cooler air from the floor to be pulled through the chamber at the bottom of the stove, creating a natural current effect which promotes increased distribution of warmth.

Your HearthStone's soapstone walls produce an incredibly even, gentle, radiant heat that travels naturally to distant rooms — in most cases, no matter where you locate the stove. But by locating the stove centrally and providing for the free flow of heated air, you can optimize uniform heating throughout your home. While not essential, an open floor plan is ideal because neither radiation nor air flow is inhibited by interior walls. Ceiling-level registers and/or fans can often help dramatically (especially in well-sealed, well-insulated houses) to move warm air that collects at the ceiling into adjacent rooms.

Locating your stove in a basement that's not insulated is a great way to heat your basement, but not the rest of your house. The amount of radiant energy required to heat your basement walls is so great that most of the useable heat is absorbed by them and lost. Fans and door registers will aid in directing warm air where you want it, but generally your HearthStone stove belongs *in your living area*.

## SECTION B: CHIMNEYS

Your stove's performance depends on the following:

1. Chimney and installation.
2. Operating technique
3. Quality of the fuel.

You can vary the operation of your HearthStone, and over the years you'll probably use wood of varying quality. But once your chimney is in place, it's usually there to stay. If you plan to use an already existing chimney, then the following information will help you determine if it is suitable for your HearthStone III. If you intend to build a new chimney, this information will help you make a good choice.

### 1. How Chimneys Work

A basic understanding of how a chimney works will help you get the most out of your HearthStone. A chimney's function is to:

1. Vent the smoke and gases safely out of your house.
2. Supply the *draft* necessary to pull air into your stove's firebox, which keeps the fire going.

Pre-Fab Metal Chimneys Fig. 1.

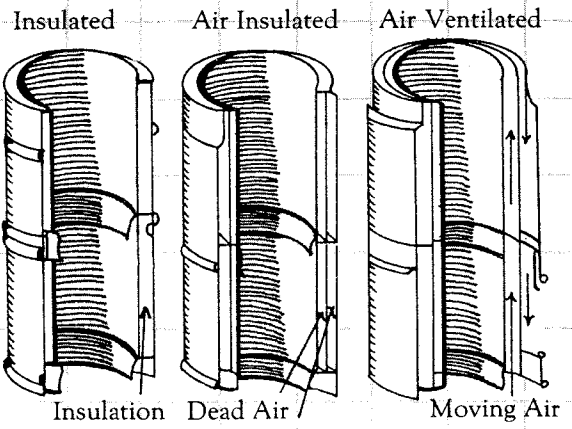
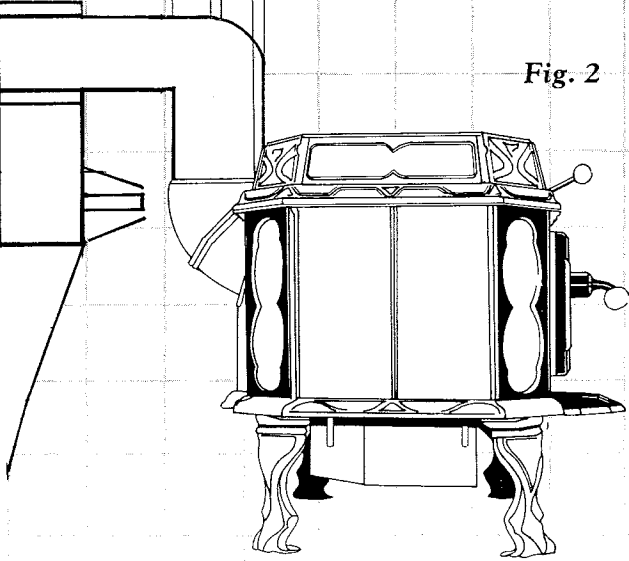

Fig. 2



Masonry Chimneys

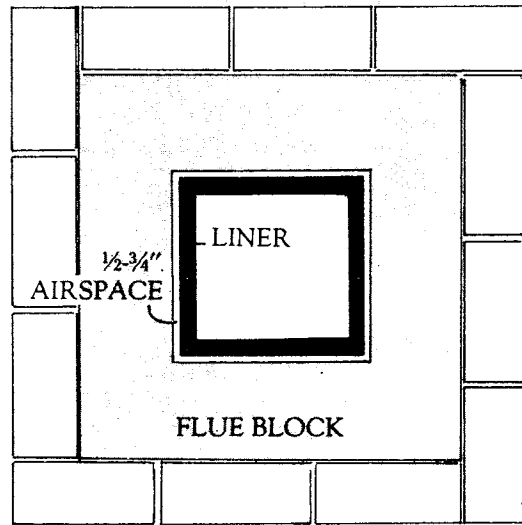

Fig. 3

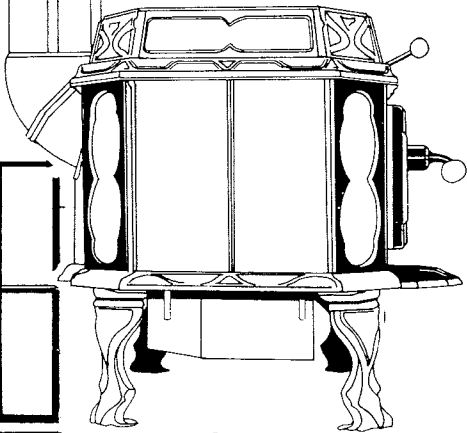
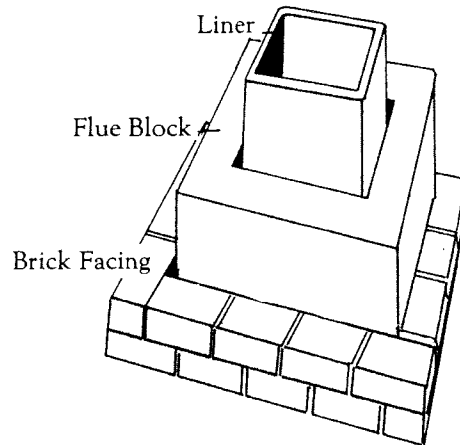
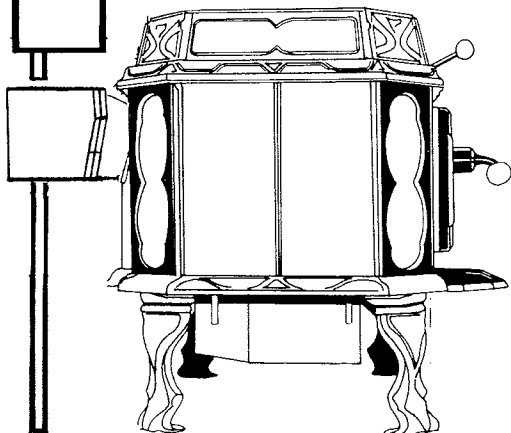

Fig. 4  
NO



## WHAT IS DRAFT?

Buoyancy, or the tendency for hot air to rise, *creates* draft. As you start a fire in your stove, the hot air rises into your chimney and is vented outside. The chimney gradually becomes hot, and aids in maintaining draft. Often, until the stove and the chimney are heated, draft is not adequate for optimum performance.

The location, size, and height of your chimney all affect the draft. Consider the following:

**\*\* Properly sized chimneys** maintain proper draft and flow. (See recommended chimney size below).

**\*\* Chimney height affects draft** — the higher the chimney, the stronger the draft. Your chimney should be at least three feet higher than the point where it passes through the roof, or two feet higher than anything within ten horizontal feet.

There are many other factors that affect draft, and, therefore, the performance of your stove. Some are:

**\*\* An "Airtight" House** — If your home is super-insulated or especially well-sealed, an inadequate supply of air entering the stove may cause a weak draft. Ducting in air from the outside to the vicinity of the stove (ideally near the primary air inlet) can correct this problem.

**\*\* Tall Trees or Buildings** — Chronic or occasional downdrafts are often a result of nearby trees and buildings damping the draft from outside.

**\*\* Wind Velocity** — Generally, the stronger a steady wind, the stronger the draft. But "gusty" wind conditions may cause down-drafts.

**\*\* Outside Temperature** — The colder the outside temperature, the stronger the draft.

**\*\* Barometric Pressure** — On balmy, wet or muggy days, draft is generally sluggish.

**\*\* "Breaks" in the chimney** — An unsealed cleanout door, leaky stovepipe joints, or other appliances vented into the same flue may cause inadequate draft.

## 2. Selection

If you plan to provide a new chimney for your stove, you have two basic choices:

1. a masonry chimney
2. a pre-fabricated metal chimney.

Tests have shown that masonry and metal chimneys of similar size do not vary greatly with respect to draft produced under similar conditions. Your personal taste, house design, and budget will dictate which chimney construction you select. Whenever possible, locate the chimney *inside* the house, as it will draw better, accumulate less creosote, and last longer.

The advantages of a masonry chimney are:

1. The mass of tile and brick helps to reduce temperature fluctuations in the chimney.
2. The heat-holding characteristics of a masonry chimney can keep a home warm long after the fire is out.
3. It can be custom-made to suit your needs and taste.
4. If properly constructed, it can be far more resistant to chimney-fire damage than metal chimneys.

Masonry chimneys should be Class A, and lined. Liners are commonly made of vitreous clay or terracotta and are designed to withstand high temperatures and corrosion. They are available in round, square, and rectangular shapes, but the *size* is most important. We recommend the following standard liners to be used in chimney construction to serve your HearthStone III:

**\*\*Round:** 6" inside diameter

**\*\*Square:** 8" x 8" outside measure

**\*\*We do not recommend the use of an unlined chimney.**

**\*\*Nor do we recommend reducing the size of the flue at any point to less than 6" in diameter.**

A simple diagram of a properly constructed masonry chimney designed to serve a HearthStone III appears on page 4.

Advantages of a pre-fabricated chimney system are:

1. It is relatively easy to install.
2. You have more flexibility in choosing a location.
3. It can eliminate flow-impeding angles.

Only Class A, all-fuel, factory built chimneys should be used. You will need a chimney of 6" inside diameter. Three common types of pre-fabricated metal chimneys are shown. The air-ventilated, or thermo-siphon type may produce excessive creosote build-up because the cool air can cause smoke and gases to condense on the inner liner.

## SECTION C: FIREPLACE INSTALLATION

Generally, fireplace chimneys, while fully serviceable, are not best for stove installation because many are over-sized and, therefore, promote premature cooling of smoke and gases. Consequently, draft may be reduced and creosote may increase. The best fireplace installation is into an interior fireplace chimney that is lined and in good repair. If the fireplace chimney you wish to use is not in good repair, we recommend lining the chimney with a stainless steel liner of the proper diameter. Figures 2 and 3 illustrate recommended methods of venting your stove into a fireplace chimney. Remember to maintain proper clearances to the fireplace mantel and any other combustible walls or materials (see Part 1, Section F).

In addition, to prevent overheating of the electronic components of the Electronic HearthStone III, the electronics box must be removed from the side of the stove and located on the hearth outside of the fireplace enclosure. Contact the HearthStone Service Department for extension wire to complete a fireplace installation.

Figure 2 allows for the easiest routine inspection and cleaning of your chimney, although it requires the installation of a thimble above the fireplace opening.

In Figure 3, the stovepipe should extend through the smoke chamber and all the way into the liner of the chimney. The damper opening through which the stovepipe passes should be sealed with either a fitted metal plate, or non-combustible fiberglass or rock wool insulation supported with plumber's strapping.

We do *not* recommend installing your HearthStone as in Figure 4 because the walls of the fireplace opening serve as a huge cooling surface that adversely affects the draft and creosote accumulation.

## SECTION D: STOVEPIPE

### 1. Installation

**NOTE:** Use of Aluminum Type B gas vent for solid fuels is unsafe, and prohibited by the National Fire Protection Association code. 24 gauge stovepipe (or heavier) must be used to connect your stove to the chimney flue. A flue collar adaptor is supplied with your stove and is required for proper installation.

Your Hearthstone III is designed for use with a 6" stovepipe. The crimped ends of the stovepipe should point down, toward the stove, and fit *inside* the flue collar adaptor, thus eliminating creosote leakage.

**NOTE:** Because of the damper in your HearthStone stove, rarely is a stovepipe damper necessary.

Each stovepipe joint should be secured with three sheet metal screws. Holes are pre-drilled in the HearthStone's flue collar to accept  $\frac{1}{8}$ " x  $\frac{1}{2}$ " sheet metal screws.

The longer the stovepipe length and/or the larger the number of elbows, the greater the chance of dangerous creosote and ash build-up. In the past, installers strove for long runs to ensure maximum heat dispersal. Consequently, stovepipe length should ideally be kept to 4' to 6' and any horizontal runs of pipe should rise a minimum of  $\frac{1}{4}$ " per foot.

Particular attention should be paid to the point where the stovepipe passes through a wall or ceiling. This penetration should *always* be made with insulated pipe and the proper accessories and, once made, the remainder of the chimney should be insulated pipe *only*.

The stovepipe should extend into the chimney or chimney thimble at least 2", but should not extend into the flue.

The illustration at right shows standard stovepipe assembly for a woodburning installation.

Drawbands and slip-joints greatly simplify the connection of stove to chimney. Additionally, they allow for easy inspection and dismantling of the stovepipe *without moving the stove*.

### 2. Stovepipe Clearances

The minimum clearance of stovepipe to combustible surfaces of 18" is well-maintained when the stove is placed 36" from the wall (see illustration A, page 8). If the HearthStone III Reduced Clearance Kit is used, the shielded stovepipe clearance may be reduced to a minimum of 15" (see illustration B). For Mobile Home installations the stovepipe clearance may be reduced to 5" using the HearthStone III Mobile Home Kit and insulated pipe (see illustration C).



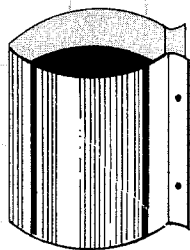
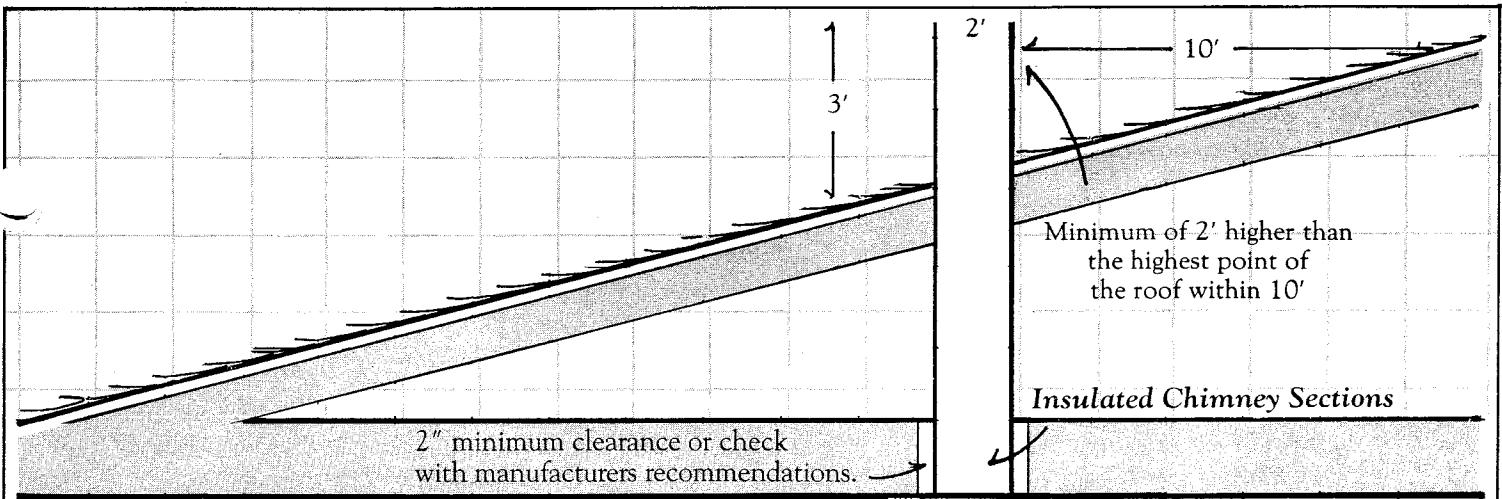

Draw Band — or — Slip Joint

18" min.

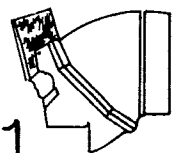
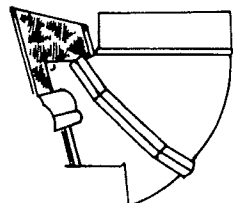
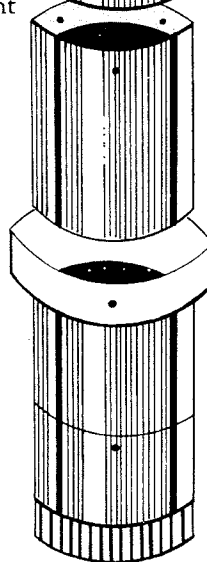
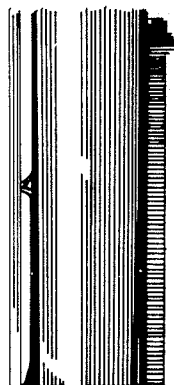

20-1/2" Flue Exit Centerline

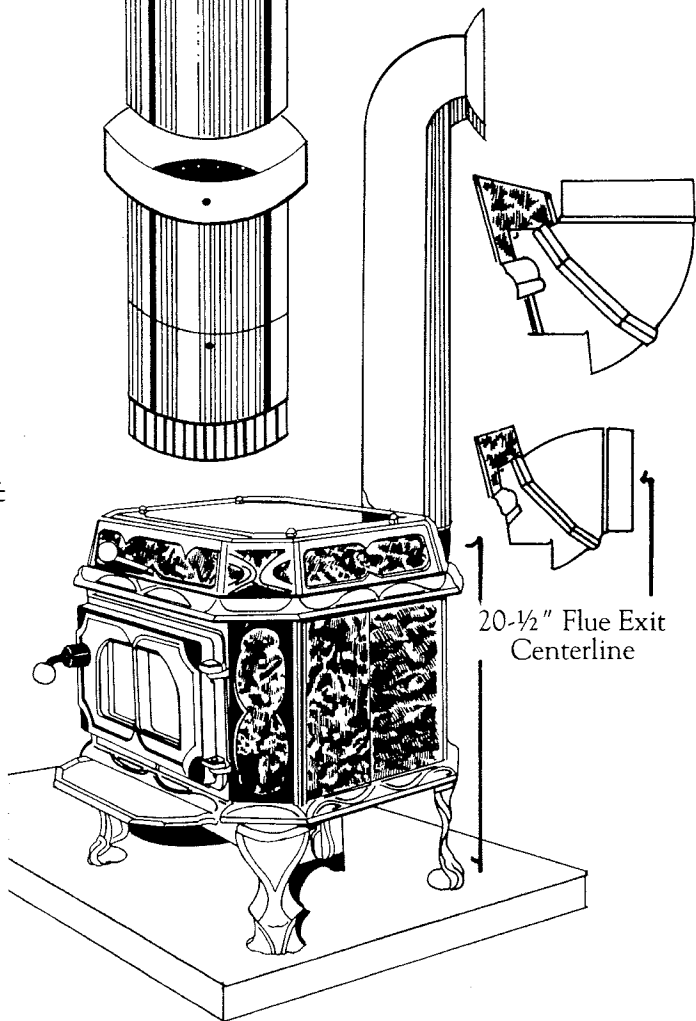
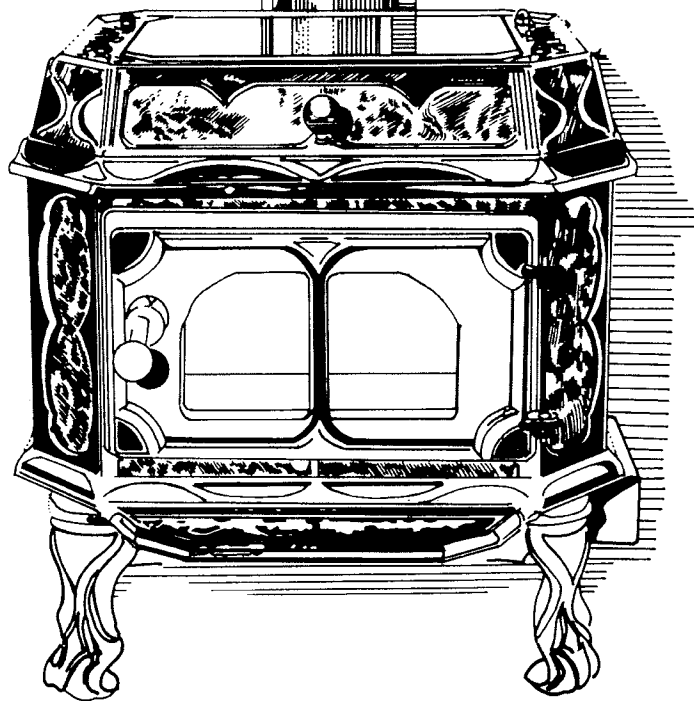

## SECTION E: HEARTHES

### 1. Hearth Composition

Local fire safety requirements may vary, but we require a minimum of 4 inches of masonry (standard brick standing on edge) mortared onto 28 gauge sheet metal over a plywood subhearth. An acceptable alternative to this composition requires use of the Hearthstone Heat Shield, which comes with your stove. When the Hearth Heat Shield is used, the hearth may be constructed of  $\frac{3}{8}$ " asbestos millboard (or equivalent) covered with a non-combustible material of any thickness (soapstone, tile, slate, etc).

### 2. Hearth Size

The hearth should extend beyond the body of the stove by the following dimensions:

Front .....	16"
Sides .....	8"
Rear .....	8"

Therefore, the recommended minimum dimensions are 40" width x 45" depth.

**NOTE:** Dimensions of the body of the stove do not include the front ashlip.

## SECTION F: CLEARANCES

The following clearances to combustible surfaces were approved by Arnold Greene Testing Laboratories, 6 Huron Drive, Natick, MA, in accordance with UL Standards.

	Unshielded	Shielded
Front .....	36"	36"
Sides .....	24"	18"
Rear .....	30"	20"

A combustible surface is one that has any combustible components, regardless of its covering. For example, a standard stud wall covered with sheetrock and further covered with brick or brick veneer is still considered a combustible surface. This is because the brick conducts heat very rapidly to the sheetrock and studs.

Without adequate clearances or a HearthStone III Reduced Clearance Kit, the wall materials will dry out over time and their ignition temperatures will be drastically reduced, therefore increasing the chances of combustion.

#### Further Information:

"NFPA 211 Chimneys, Fireplaces, Vents and Solid Fuel Burning Appliances 1984" National Fire Protection Association. The address is: NFPA, Battery March Park, Quincy, MA 02269.

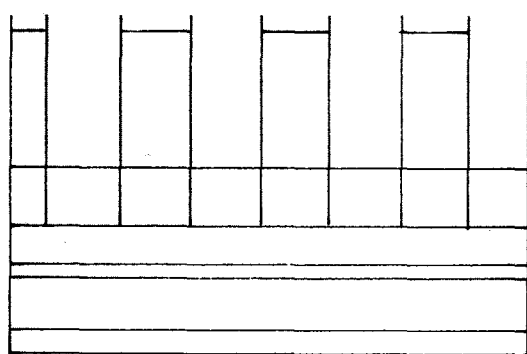

1. Brick  
2. Metal  
3. Plywood

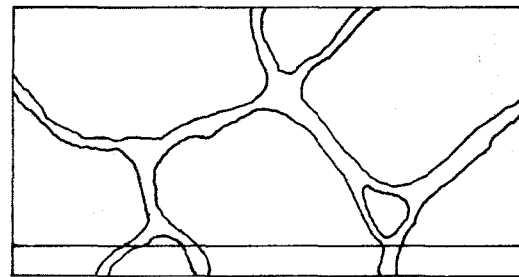

1. Slate  
Must be used with bottom heat-shield  
2. Millboard

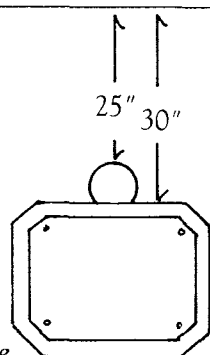

2. Hearth Size

A. Unshielded

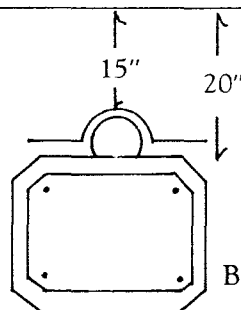

B. Shielded

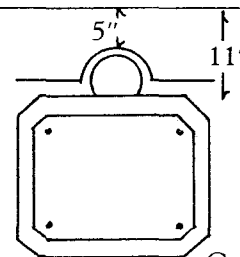

C. Mobile Home Kit With Insulated Pipe

# II

## OPTIONS

**A** Reduced Clearance Kit and a Mobile Home Kit are both available for the HearthStone III. Instructions for the installation of these options will come with the Kit.

1. **The Reduced Clearance Kit** includes: a HearthStone III Rear Heat Shield and 6' of stovepipe shield.

\*\*\*Please note that if your stovepipe length exceeds 6', you must order additional sections of stovepipe shield for any length of stovepipe that will be closer than 15" from the wall or 18" from the ceiling.

2. **The Mobile Home Kit** includes: a Mobile Home Rear Heat Shield, an outside air adaptor and a transition piece for mating the flue collar to the Class A chimney sections.

\*\*The transition piece is designed to accept 6" inside diameter Metalbestos or Security brand Class A, all fuel, factory built chimney sections.

2. **Make the proper connection from the flue collar to the chimney.** (See Part I: Installation, Section D: Stovepipe).

3. **Connect the digital electronic air control system.** The components of the system include: the air intake control, the electronics box, a power cord, a thermostat and 20 feet of thermostat wire. The air intake control is on the back of the stove in the lower right-hand corner (in earlier models, it is located on the lower right side of the stove). The electronics box is on the lower right-hand side underneath the stove (on the lower left side for earlier models). The power cord, thermostat and thermostat wire are shipped inside the stove.

(a) First, check the connections from the electronics box to the air intake control and the thermocouples. If they have come loose during shipping, reconnect as follows:

Find the thermocouple wires (the brown and yellow wires) on the back of the stove. The upper wire comes from the flue collar and the lower wire connects to the secondary combustion chamber. Connect the upper wire to the electronics box at point "A," with the locking lip toward the stove. Connect the lower wire to the electronics box at point "B," with the locking lip toward the stove. Then find the plug from the air intake control and insert it at hole "C," with the flat side of the plug toward the stove.

(b) Connect the thermostat wire to the electronics box by inserting the two-wire plug with lip toward the stove at point "E."

(c) Select and mark the thermostat location, according to the instructions packaged with the thermostat.

(d) Connect the thermostat wire directly to the terminal screws on the front of the thermostat base. You can feed the wires through the gap between the thermostat cover and the thermostat base, or through any of the holes in the thermostat base. Note: the Hearthstone III thermostat can also be wired directly into the wall like any other standard heating thermostat.

(e) Mount the thermostat on the wall, according to the instructions packaged with the thermostat.

(f) Connect the three-wire power supply cord to the electronics box at point "D," with the locking lip toward the front of the box.

(g) Plug the other end of the power supply cord into any standard three-prong grounded wall outlet.

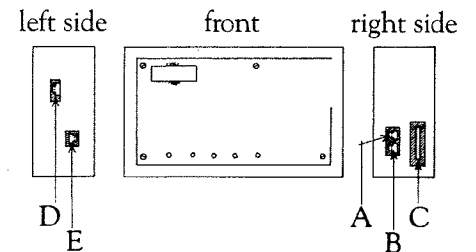

# III

## ASSEMBLY

**Y**our HearthStone is completely assembled. Once situated on your hearth, all that remains to be accomplished is:

1. **Attach the flue collar** (packaged inside the stove with hardware and gaskets). For top vent installations, make sure the exit hole is facing up. For rear vent installations, the exit hole should be facing away from the stove.

### HearthStone III

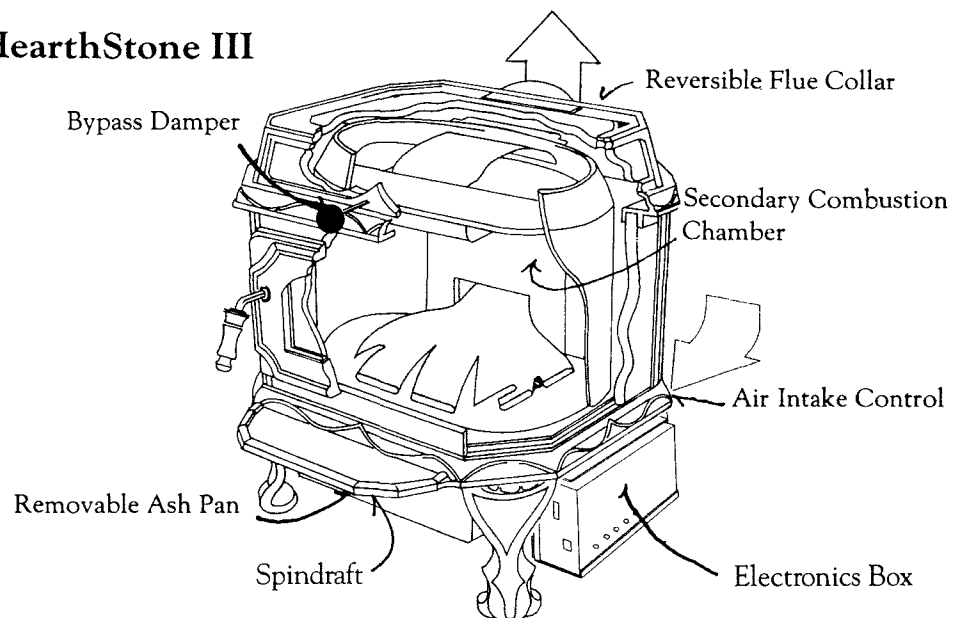

# IV

## OPERATION

### SECTION A: THE CONTROLS OF THE ELECTRONIC HEARTHSTONE III

**Y**our stove has been designed to be the easiest, least time-and-attention-requiring fireplace stove available today. Although operating your stove is quite simple, wood-burning is a complicated process with a number of variables, and it takes time and experimentation to understand how these variables interact. With patience, you will learn how to operate your stove to best suit your needs. Before lighting your first fire, familiarize yourself with the controls of your stove.

**1. The digital electronic air control system** is composed of two elements: the air intake control and the electronics. The air intake control is attached to the back of the stove in the lower right hand corner (on the lower right side of the stove for earlier models). This device regulates the amount of air entering the combustion chamber, and thus controls the rate at which the fuel is burned. The air intake control is signalled to admit air, and how much air, by the electronics. Three wires run from the electronics box to the stove: one to the flue collar, one to the combustion chamber and one to the air intake control. Through these wires the electronics monitor the temperature in

the stove and send signals to the air intake control.

The electronics box is on the bottom right side of the stove (bottom left side on earlier models). Newer models of the electronics box are equipped with five color-coded Light-Emitting Diodes (LEDs) which provide considerable information about the operation of the stove. During normal operation, the LEDs will switch on and off in various combinations as the stove passes through different phases of the burn cycle.

LED #4 (red) indicates that the stove is plugged in to the wall outlet. It should be on whenever the stove is in use.

LED #1 (yellow) is the "fire almost out" light. When this light comes on, usually at the very beginning or end of the burn cycle, it means that the flue exit temperature is less than 200 degrees. In this situation, the "End of Fire Shutdown" feature will close all air intake to the stove, preventing warm room air from being drawn through the stove and up the chimney. Therefore, when starting a fire, wait until LED #1 goes out before closing the spindraft (see below).

LED #3 (yellow) comes on when the fire is fully established, indicating that the

secondary combustion chamber is above 1200 degrees and within the clean burn range. This light will remain on throughout most of the burn cycle, but may go off momentarily when the stove is in transition from high to low controlling range.

LED #2 (red) will come on whenever the room temperature reaches the thermostat setting.

LED #5 (green) comes on when your stove is operating at peak efficiency within its low or high heat controlling range. The system will select high range when the thermostat is calling for heat. Once the thermostat is satisfied, it will revert to low range until the thermostat once again calls for heat or the fuel supply is exhausted.

In addition to the LEDs, the electronics box is equipped with a buzzer which will sound in the event of overheating.

**2. The wall-mounted thermostat** senses room temperature and signals the digital electronic air control system to maintain either an efficient low or high burn rate. Please keep in mind that the thermostat responds to **room air temperature**, not the temperature of the air

Light No.	Color	Phase	When the Light Is On...	When the Light Is Off...
1	yellow	Fire Almost Out	The flue exit temperature is less than 200 degrees	The flue exit temperature exceeds 200 degrees
2	red	Thermostat Satisfied	The thermostat is satisfied	The thermostat is calling for heat
3	yellow	Second Chamber Ignited	The secondary combustion chamber is at least 1200 degrees	The secondary combustion chamber temperature is less than 1200 degrees
4	red	Power On	The stove is plugged in	The stove is not plugged in
5	green	Controlling Range	The stove is operating within its optimal low or high controlling ranges	The stove is not operating within its optimal low or high controlling ranges

surrounding the stove. You will probably find it necessary to experiment with different thermostat settings in order to find the one that is most comfortable for you.

When you first start a fire in a cold room, the thermostat will direct the digital electronic air control system to admit sufficient air for the highest rate of combustion. When room temperature reaches the thermostat setting, the electronic controls will adjust the flow of air to the stove to maintain an efficient low burn rate until the wall thermostat calls for more heat. **All of this is done automatically and requires no adjustments other than setting the thermostat.**

3. **The spindraft** on the ashpan door serves as a "quick-start" control and a manual air control override. Spin the control counter-clockwise to admit sufficient air to get the fire started. Once the kindling is well ignited (LED #1 goes out), close the spindraft completely, as the electronics will not function properly if the control is left open after fire-starting.

In case of a power failure or overheating, the digital electronic air control system will close all air intake to the stove and extinguish the fire. To operate the stove during a power failure, simply open the spindraft, start a fire, and adjust the spindraft to admit sufficient air for the rate of burn you wish to maintain. **Be sure to close the spindraft once power has been restored.**

**Warning:** NFPA regulations require an outside air source for mobile home installations. The spindraft on the ashpan door must be blocked off with the plate provided in the HearthStone III Mobile Home Kit if your stove is to be installed in a mobile home.

4. **The bypass damper** is located above the door inside the stove and is controlled by the knob above the door—to open, push in; to close, pull out.

\*\* Closed, the damper diverts combustion gases from the main combustion chamber to the secondary combustion chamber, where they are thoroughly mixed and very completely burned.

\*\* Open, the damper allows the direct exit of combustion gases to the flue. The smoke and gases encounter less resistance, and are free to move easily up the stovepipe and into the chimney.

## WHEN TO OPEN THE BYPASS DAMPER

\*\* When starting the stove.

\*\* When operating the stove as a fireplace.

\*\* For 5-15 minutes after reloading with fuel.

\*\* To boost the draft as necessary.

\*\* Before opening the door.

## WHEN TO CLOSE THE BYPASS DAMPER

\*\* Once the fire in your stove is well established to allow for maximum efficiency and heat transfer.

The procedure for operating your Electronic HearthStone III is as follows:

1. Set the thermostat
2. Open the bypass damper
3. Load the firebox and light the fire.
4. Close the door.
5. Open the spindraft. Do not leave the stove at this time.
6. When the kindling is well ignited (LED #1 goes out) close the spindraft.
7. After 5-15 minutes, close the bypass damper.

If the fire seems to die out after you close the bypass damper, open the damper halfway, which will allow for enough air flow to warm up the combustion chamber. Once the chamber is sufficiently warm, and the fire is burning properly, close the bypass damper completely.

## SECTION B: THE CONTROLS OF THE MANUAL HEARTHSTONE III

Your Manual HearthStone III is identical in design to the Electronic model except that it does not have the digital electronic air control system.

The spindraft control on the ashpan door is the primary air intake. To open, turn counterclockwise; to close, turn clockwise. To maintain maximum combustion chamber efficiency, the spindraft should be left at approximately  $\frac{3}{4}$  to  $1\text{-}\frac{1}{4}$  turns open. However, the spindraft can be adjusted to maintain whatever heat output you desire, or when more air is needed during re-loading and firestarting.

The bypass damper performs the same function as in the Electronic Model. For detailed information on operation of the bypass damper, please refer to Part IV, Section A, 4.

The procedure for operating your Manual Hearthstone III is as follows:

1. Open the bypass damper.
2. Load the firebox and light the fire.
3. Close the door.
4. Open the spindraft completely (about 8 full revolutions) until the kindling is well ignited. Do not leave the stove at this time.
5. After 5-15 minutes, close the spindraft halfway.
6. When the fire is well established, close the spindraft completely, then adjust it to between  $\frac{3}{4}$  and  $1\text{-}\frac{1}{4}$  turns open, where it should be left to maintain maximum combustion efficiency.

An optional combustion monitor allows you to understand precisely when the stove is operating at peak efficiency. Contact the HearthStone Service Department for more information.

## SECTION C: BREAKING IN YOUR STOVE

### 1. *The Reasons for Break-in*

It is imperative that your stove be broken in very slowly. There are several reasons why:

1. Cast-iron must be "seasoned"—over-firing a new stove may cause the bottom casting to crack and damage other stove parts.
2. Moisture in the soapstone must be driven out slowly to minimize the "shock" to the stone of its first exposure to high firebox temperatures.
3. The asbestos-free furnace cement must be cured slowly to ensure adequate sealing and bond.

### 2. *The First Fires*

Before building your first fire, the bottom casting of your stove must be protected. Sprinkle a layer of common sand or ash on the slotted wood grate—not in the ash pan—(approximately  $\frac{1}{2}$ " depth). Build the fire directly on the wood grate.

To build your first fire, place five or six double sheet, tightly twisted pieces of newspaper on the grate. Arrange kindling in a criss-cross pattern over the newspaper—approximately 10 pieces,  $\frac{1}{2}$ " diameter, 10" to 16" long. Check to make sure the bypass damper is in the open posi-

tion and that the spindraft is fully opened. In Electronic models, plug in the power cord and set the thermostat to the desired room temperature.

To get the draft started, it may be necessary to light a piece of newspaper (hold the tightly twisted end, light the loose end) and hold it up inside the firebox above the front door. When the chimney begins to draw (you will feel it "grab" the fire at the end of the paper), light the paper under the kindling. Close the door. When the kindling fire is well ignited:

**Electronic models:** Close the spindraft completely. If the kindling fire dies out for lack of air after closing the door, then allow the kindling fire to become fully established (make sure LED #1 has gone out) before closing the spindraft.

**Manual models:** Close the spindraft halfway. When the fire is fully established, close the spindraft completely and then adjust it  $\frac{3}{4}$  to  $1\frac{1}{4}$  turns open.

Under a watchful eye, maintain a steady, low-heat fire. We recommend a stovetop thermometer reading of no more than 150 degrees (very warm, not hot, to the touch) for your first and subsequent break-in fires. Once these temperatures are achieved:

**Electronic models:** Unplug the power cord, which will close all the air intake to the stove.

**Manual models:** Close the spindraft completely.

Allow the fire to die out completely and the stove to return to room temperature.

We recommend that your first three fires be built and maintained accordingly. Your patience will be rewarded by a properly seasoned HearthStone.

## SECTION D: EVERYDAY USE

### 1. General Guidelines

Once properly broken in, your HearthStone III is ready for continuous operation. The heat demands of your living area will determine how frequently you will have to load your stove, but, generally, you will probably find it necessary to add a charge of wood four to six times every 24 hours.

If your stove is not to be used continuously, we recommend a relatively small fire when starting a cold stove. Let all the stove surfaces become uniformly warm before loading for a hot fire.

The following is a list of guidelines for in-season, everyday use:

- \*\* Burn well-seasoned, dry wood — preferably hardwood because of the higher BTU content per piece. (Well-seasoned firewood is that which has been cut, stacked, and covered for a minimum of one year and has a 16% to 20% moisture content).
- \*\* The firebox is designed to accept a maximum log length of 16". However, to maximize the size of the fuel load, *the log length should vary from 12" to 16"*.
- \*\* Reload on a bed of hot, red coals. This practice reduces smoking time and will bring fresh fuel up to high temperature rapidly.
- \*\* Avoid "one stick fires." A good fire requires several logs in close proximity to maintain adequate temperatures for efficient combustion.
- \*\* Remove ashes as frequently as necessary. Excessive ash build-up will actually reduce the output of your stove.

**NOTE:** The proper tool makes all the difference for "tending" of ashes. We recommend a small fireplace hoe. Raked across the wood grate of the HearthStone III, fine ash is encouraged to fall through the slots in the grate.

### 2. Fireplace Operation

Although the controlled combustion mode provides maximum heating efficiency, there may be times when you will want the warm, cheerful atmosphere that only an open, crackling fire can provide. However, in Electronic models, the volume of air supplied to the fire with the door open will override the functions of the digital electronic air control system. Therefore, the room temperature will not be determined by the thermostat setting. When operated with the door open, the HearthStone III provides direct heat appreciated on chilly mornings. And, while doing this, it is still doing what it is

designed to do best: storing heat in its soapstone panels.

To Convert to a Fireplace:

1. Open the bypass damper.
2. Open the front door, being sure to always insert a safety spark screen to prevent sparks from flying out.

**NOTE: It is neither approved nor recommended to burn your HearthStone III as a fireplace when installed in a mobile home. Oxygen depletion and/or excessive stove temperatures may result.**

### 3. Overfiring Caution

Overfiring means running your stove at excessively high temperatures for extended periods of time. Because it can cause damage to the stove, it should be carefully prevented.

The Electronic Hearthstone III has a temperature limit designed into the digital electronic air control system. A temperature sensor in the flue collar allows maximum heat output and yet prevents the stove from overfiring. In the event of an overheat situation, a buzzer in the electronics box will sound and all air intake to the stove will be closed until you correct the situation (close the door, close the spindraft and/or unplug the stove). Caution: When operating the Electronic model manually, or when operating the Manual model, be careful not to overfire. **Never operate either model with the ashpan door open.**

Examples of the damage caused by overfiring are: blistering or bubbling of porcelainized surfaces, damage to the digital electronic air control system or warping of the internal firebox components. **ANY OF THESE SYMPTOMS OF OVER-FIRING WILL VOID YOUR WARRANTY.**

# V

## MAINTENANCE

**Y**our HearthStone III is an appliance that is subjected to temperature extremes and the corrosive residues of burning wood for long periods of time. Periodic maintenance is essential to keep your stove performing as it should. All parts and special maintenance kits are available through HearthStone or your local dealer.

### SECTION A: DURING THE HEATING SEASON

**Every Day:** Check ash accumulation and remove ashes, if necessary. In Electronic models, care should be taken not to push any ashes back through the air inlet manifold, and thus into the air intake control.

**Every Two Weeks:** Visually inspect stovepipe and chimney for creosote accumulation. (See Section F)

**Every Eight Weeks:**

1. Check door frame seals by closing the door on a dollar bill when the fire is out. If the dollar bill pulls out easily:

Tighten the fit of the door by removing a washer from the inside of the handle and replacing it on the outside of the handle. To do this, tap the pin out of the handle assembly with a  $\frac{3}{16}$ " pin punch or a blunt nail. Remove the handle and washers and then pull out the catch. Move one of the washers from the catch side to the handle side. Replace the catch, washers and handle and tap in the pin with a hammer. If this

does not sufficiently tighten the door seal, then replace the door gasket.

2. Remove and shake or brush the filter screen on the air intake control.

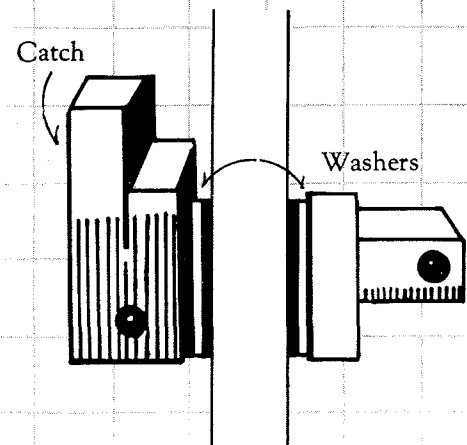

Tightening the Door  
HearthStone III

### SECTION B: AT SEASON'S END

1. Dismantle stovepipe and clean thoroughly. Replace any pieces that show signs of rust or deterioration.

2. Inspect and clean your chimney, if necessary. (See Section F.)

3. Thoroughly vacuum out the inside of your stove. Inspect interior for any signs of damage or deterioration.

**NOTE:** Soot and creosote that collects on the walls of your stove will dramatically reduce heat output.

4. Inspect gasket material in all doors and replace if worn, frayed, cracked or extremely hard. Normally, gasket material should be replaced every two or three seasons.

5. Repaint castings, if necessary.

6. Follow instructions for inspection (see Every Eight Weeks, Section A).

7. Unplug the power cord (Electronic models).

### SECTION C: STONE FINISH

Often, subtle earth tones of brown, red and yellow appear in the soapstone with use. This is a natural reaction of the soapstone and cannot be controlled. If your stove is a Brownstone, you may, under very close inspection,

find an occasional fine surface crack in the stone. Such a hairline crack is just on the stone surface, and does not affect the integrity of the stone in any way.

Occasional cleaning and/or polishing is all that should be necessary to keep your HearthStone looking beautiful. Care must be taken, however, to prevent scratching or chipping the stone. Brief instructions follow for general care of the soapstone.

**\*\*Natural Grey Unpolished Soapstone:** Any surface scratches or discoloration can be removed by lightly sanding with fine sandpaper (200-220 grit). Stains may need a sprinkle of cornstarch before sanding. Wipe the stone with a clean cloth after sanding to remove any dust. Never use water or a liquid cleaner on unpolished soapstone.

**\*\*Polished Soapstone and Brownstone:** As with fine furniture, you may wish to polish the stone periodically to renew the original luster and depth of color. We recommend Krylon silicon spray. Apply it to the stove when the fire is out, and the stone is just warm to the touch, or cooler.

Spray the stone, let dry and wipe to remove excess and bring up the polish. How long fresh polish lasts will depend on stove use and/or atmospheric conditions.

## SECTION D: CASTINGS

All of the HearthStone III's cast-iron pieces are treated with a special high temperature paint. A damp sponge will do a fine job of cleaning them. Small cans of the paint are available for touch-up at the end of the heating season. (Contact the HearthStone Service Department). The porcelainized enamel castings of the Brownstone model can be cleaned with a standard glass cleaner. With time and use, a very fine subtle network of craze lines will appear seemingly beneath the surface. crazing is a natural, predictable process and does not represent a flaw in the castings.

However, overfiring will severely damage the the porcelainized finish. Evidence of overfiring is a blistering or bubbling of the porcelainized door or castings. This is caused by temperatures in excess of 1600°F. If this should happen, the repairs **will not** be covered by your warranty.

## SECTION E: GLASS

### 1. *Cleaning*

The most effective method of keeping the glass clean is to carefully place burning logs toward the front of the stove. Generally a hot fire will burn off most of the soot. For heavier deposits, a razor window scraper will quickly and easily remove the residue. However, be sure to change the blade after each cleaning to prevent scratching the glass. Commercial glass cleaners are also effective.

**Never attempt to clean the glass while a fire is in the unit.**

**NOTE:** If doors are consistently sooted, the fire is too cool and rapid creosote buildup may be occurring in the stovepipe and chimney. Inspect and clean as necessary.

### 2. *Glass Replacement*

The inner glass in your HearthStone is a ceramic thermal shock-resistant glass made specifically for wood and coal stoves, and should not be substituted. The outer glass is a tempered borosilicate glass and will not withstand high temperatures without the protection of the inner glass. **In the event of breakage of either pane, replace immediately.** Contact HearthStone Customer Service Department for replacement glass which will be accompanied by complete instructions for removal of cracked or broken glass and proper replacement of the new glass and gasket material.



## SECTION F: STOVE-PIPE AND CHIMNEY

### 1. Creosote Formation and Need for Removal

When wood burns slowly, it produces tar and other organic vapors which combine with moisture to form creosote. The creosote vapors can condense in a relatively cool chimney flue of a slow-burning fire. As a result, creosote residue accumulates on the flue lining. When ignited, this creosote makes an extremely hot fire. Any accumulation of  $\frac{1}{8}$ " or more should be removed immediately.

Because of the many variables that affect how quickly or how much creosote accumulates, it's impossible to state how often it is really necessary to clean your stovepipe and chimney. *Visual* inspection is the only way to tell, so we highly recommend that you install your stove so that inspection and periodic cleaning is as easy as possible. A clean stovepipe and chimney go hand-in-hand with the woodburner's peace of mind.

### 2. Inspection

Slip-joints and drawbands (See Part I, Section D) are stovepipe component pieces that make both inspection and cleaning very simple. The slip-joint and/or drawband are most useful when the stovepipe configuration requires that the pieces be dismantled for cleaning outdoors. A small mirror attached at an angle to a long handle allows for easy inspection once the drawband has been removed, or the slip-joint has been dropped.

When inspecting a masonry chimney, the cleanout door is the place to start, normally found either outside or in the basement at the base of the chimney. The long-handled mirror is once again the best tool for inspection. If your chimney was not constructed with a cleanout door, it must be inspected by either looking directly up through the damper of the fireplace, or through a thimble with the mirror. At times, inspection from the top of the chimney is the only practical method.

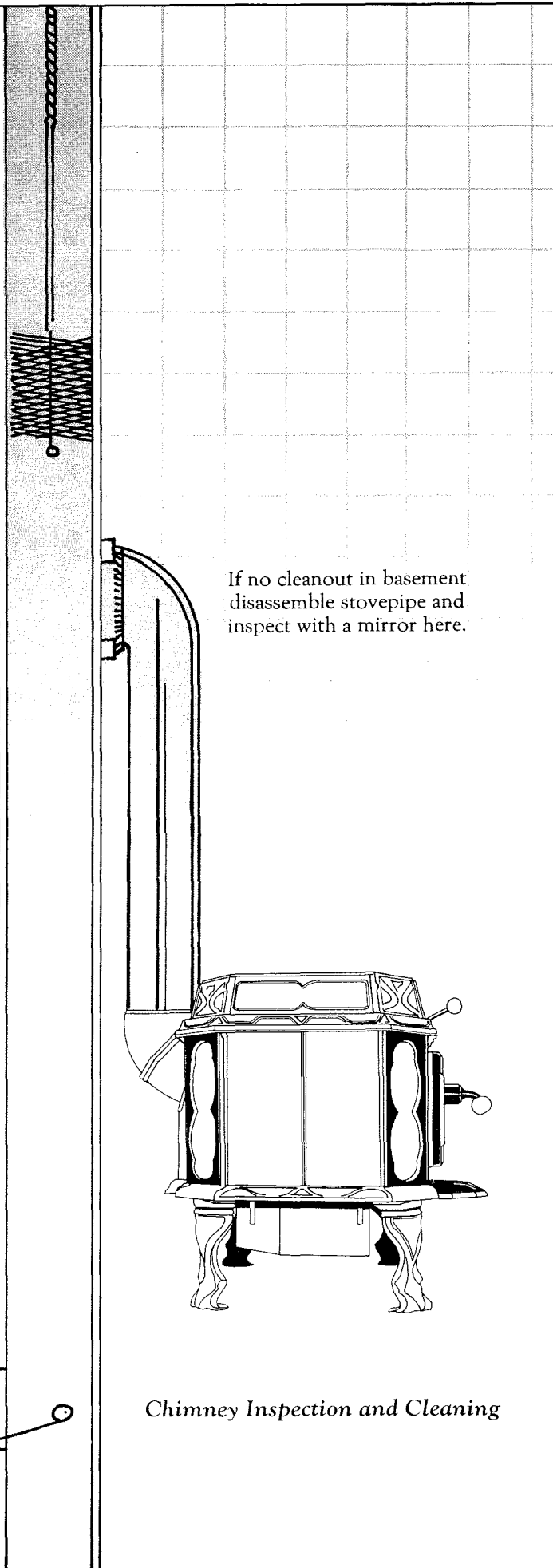

If no cleanout in basement disassemble stovepipe and inspect with a mirror here.

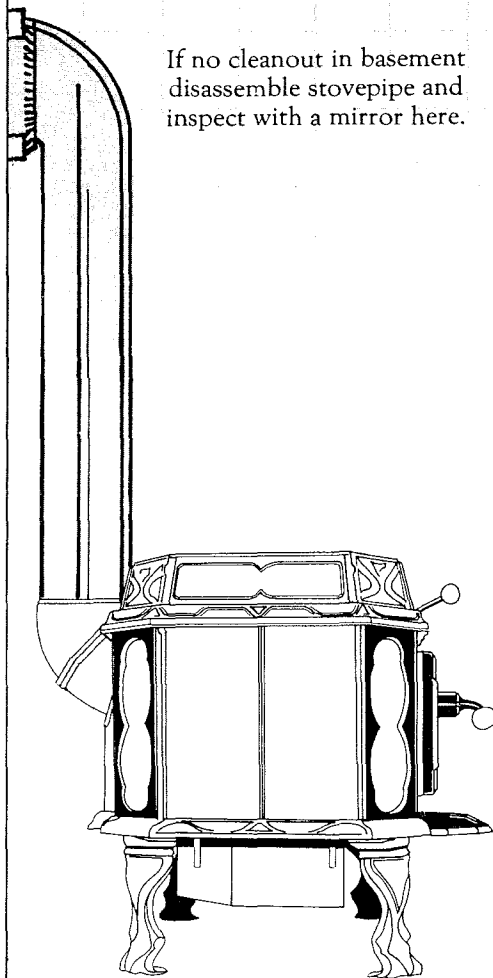

*Chimney Inspection and Cleaning*

Cleanout Door

Inspection Mirror

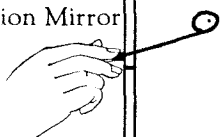

# VI

## SAFETY

### SECTION A: GENERAL PROCEDURES

**T**here are certain risks that are taken when using a solid fuel heater — be it HearthStone, or any other stove. These risks can be minimized, however, if proper installation and sensible operating procedures, as outlined in this manual, are followed. Additionally, we urge you to use *common sense!* The following is a list of safety precautions:

1. Always keep combustible items (furniture, drapes, curtains, clothing, etc.) a considerable distance from the stove. We recommend a *minimum of 36"*.
2. Do not over-fire your stove! If the stovepipe and castings of the stove begin to creak, change color, or the porcelainized castings begin to blister, you are *over-firing*.
3. Install a smoke alarm.
4. Keep a fire extinguisher handy. We recommend the type rated A,B,C.
5. Ashes should be placed in a metal container with a tight fitting lid. The closed container of ashes should be removed from the house immediately. If the ashes are disposed of by burial in the soil or otherwise locally dispersed, they should be retained in the closed container until all cinders have thoroughly cooled.
6. Never use gasoline-type lantern fuel, kerosene, charcoal lighter fluid or similar liquids to start or "freshen-up" a fire. Keep all such liquids well away from the stove while it is in use.
7. Keep pets and children away from the stove.
8. Inspect your stovepipe and chimney frequently for creosote

accumulation and clean, if necessary.

9. Never put articles of clothing or candles on a hot stove.

### SECTION B: SAFETY FEATURES

The Electronic HearthStone III has several safety features designed into the digital electronic air control system:

**1. Temperature Limit:** The digital electronic air control system senses the temperature in the flue collar and limits the amount of heat the stove is allowed to generate. This will prevent overfiring while allowing the stove to perform within the highest permissible heat output range. Whenever the stove enters an overheat situation, a buzzer in the electronics box will sound and all air intake to the stove will be closed until the situation is corrected (see Part IV, Section D, 3).

**2. Power Failure Shut Down:** In the event of a power failure the digital electronic air control system will shut down all air intake. This will prevent the stove from running without any controls in case you are not at home when the power goes out. (See Part IV, Section A, 3. Manual Air Control Override.)

**3. Quick System Shutdown:** If for any reason you need to shut off all air intake to the stove, unplug the power cord from the wall socket.

### SECTION C: EMERGENCY PROCEDURES

#### *In the Event of a Stovepipe or Chimney Fire*

Electronic models:

1. Unplug the stove from the wall socket. This will cause the valves of the air intake control to close.
2. Make sure that the spindraft, front door and ashpan door are closed.
3. Close the damper in the stove.
4. If a damper is installed in the stovepipe, close it gradually.
5. Call the fire department.
6. Keep an eye on the stove, stovepipe and chimney.

#### Manual models:

1. Close the spindraft completely.
2. Make sure the front door, ashpan door and spindraft are closed.
3. Follow steps 3-6 on the previous page.

Once the fire has expired, continue to keep all air inlets closed and let the fire in the stove die out completely. **The stove should not be fired again until the stove, stovepipe and chimney are all thoroughly inspected for any sign of damage.** Damage should be corrected immediately.

## VII

### TROUBLE-SHOOTING

**T**he following is a list of problems that are common to virtually all wood stoves at one time or another. All of the problems are correctable, and, often times, require only a minor adjustment of the stove or operating technique. Remember that the weather conditions **drastically** affect stove performance... most problems caused by the changing weather will be very temporary.

#### SECTION A: SMOKING

If your stove smokes when you open the front door, it is most assuredly caused by insufficient draft. First, inspect your stovepipe and chimney for creosote accumulation and clean, if necessary. If the insufficient draft is caused by an undersized or oversized chimney (See Part I, Section 2.), a draft inducer or raising the height of the chimney may be the only permanent cure. Smoking may also be the result of restricted or reduced airflow in the stovepipe (See p. 4). If the outside temperature is mild, try opening the damper wide for several minutes *before* opening the

door. This will invigorate the fire and heat up the chimney, thereby creating a stronger draft. If your stove *consistently* smokes and is vented into a proper chimney, open a window. If this corrects the problem, it's an indication that your house is tight enough that a supply of outside air may be necessary.

#### SECTION B: INSUFFICIENT HEAT

If you are not getting adequate heat output from your stove, there are several things you should check:

1. Make sure that the wood is making contact with the coals and is not hung up in the firebox.
2. Inspect your chimney for heavy creosote accumulation.
3. Clean out the ashes and make sure that the entrance to the secondary combustion chamber (at the bottom rear of the firebox inside the stove) is not blocked.

In Electronic models, also make sure that the power cord is plugged into the wall socket. Finally, determine if the digital electronic air control system is working properly. While the stove is burning, listen closely to the air intake control as you unplug the power cord. If the system is working, you should hear the air valves close with a click. If the system is not



working properly, call the HearthStone Service Department or an Authorized HearthStone Dealer. **DO NOT OPEN THE AIR INTAKE CONTROL OR THE ELECTRONICS BOX.** Any repairs to the digital electronic air control system should only be made by a HearthStone Service Representative or an Authorized HearthStone Dealer. The stove may be operated manually until repairs can be made.

# VIII

## FUELWOOD INFORMATION

**T**he quality of your fuelwood is an important variable which determines both heat output and duration of burn. Softwoods generally burn hotter and faster, while hardwoods burn longer and produce more coals. The *density* of the wood is the critical factor to consider when either purchasing wood or assessing your stove's performance. For your reference, we have provided a list of wood species and their relative BTU content.

**High:** Ash, Black Birch, Hickory, Hophornbeam, Locust, White Oak, Black Beech

**Medium High:** White Ash, Beech, Yellow Birch, Sugar Maple, Red Oak

**Medium Low:** Black Ash, White Birch, Grey Birch, Elm, Norway Pine, Pitch Pine, Black Cherry, Soft Maple, Tamarack

**Low:** White Pine, White Cedar, Balsam Fir, Spruce, Aspen, Basswood, Butternut, Hemlock

Moisture content also plays a key role in the performance of your stove. Wood that is freshly cut from a living tree (green wood) has a great deal of moisture in it. To properly season green wood, it should be split and stacked and allowed to air dry for a period of six months to one year. Ideally, it should be stacked on skids or blocks to keep it off the ground, and only the top should be covered. (Plastic or tarps that cover the *sides* of the woodpile trap moisture and prevent the wood from drying.) As for stacking, an old Vermonter said: "The spaces between the logs should be large enough for a mouse to get through, but not for the cat that's chasing it."

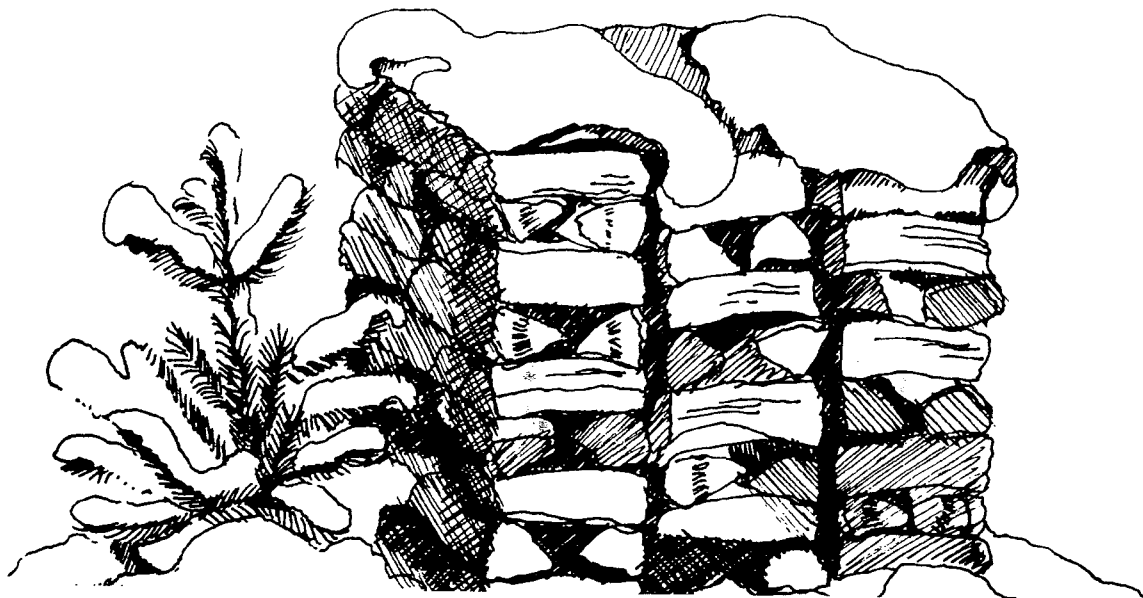

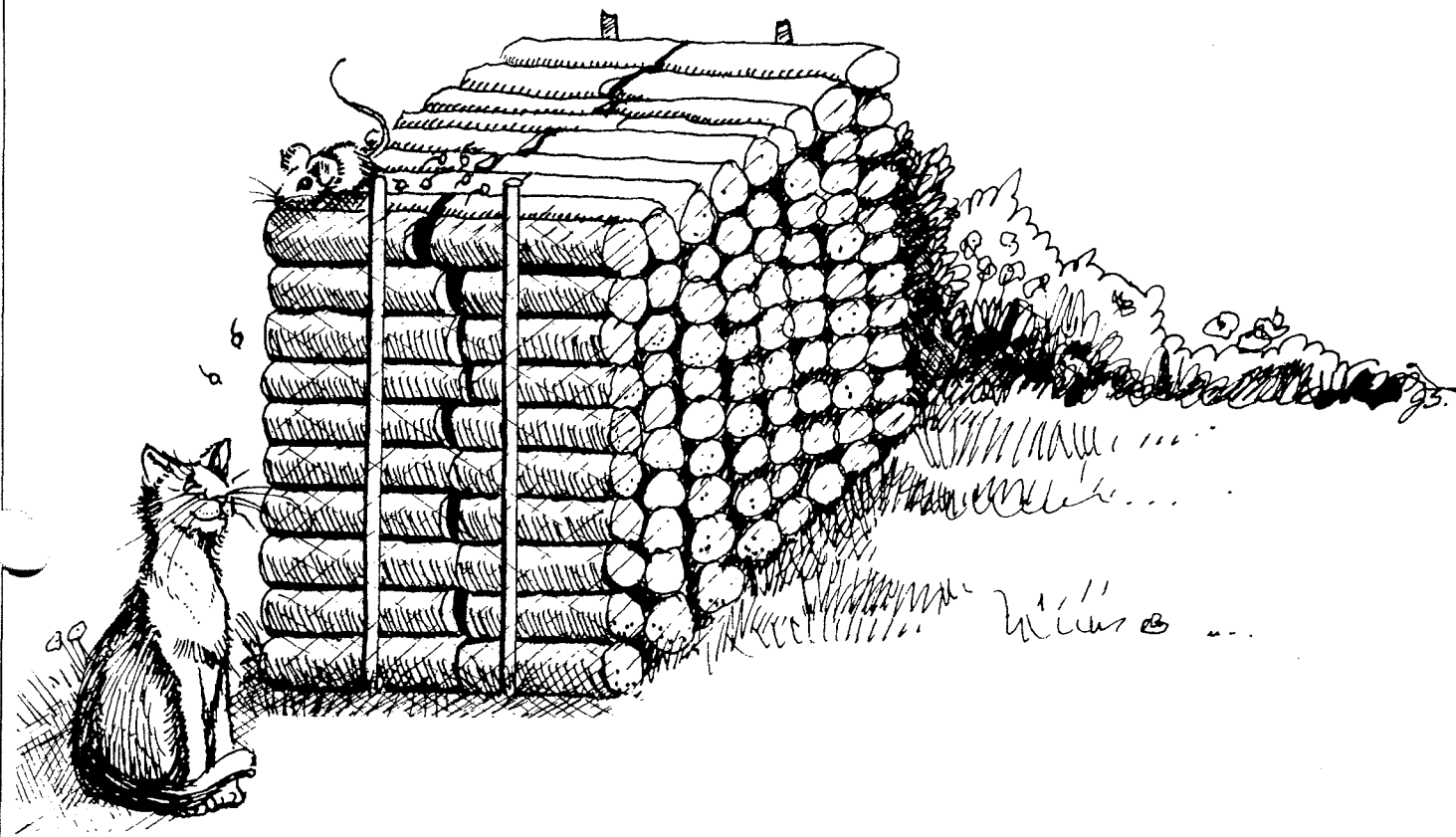

## IN CLOSING...

**W**ith proper use and care, your new HearthStone III will serve you faithfully for years and years to come. We recommend that you keep this manual in a safe and convenient place and refer to it whenever a question arises. Should you ever have any unanswered questions, problems or comments concerning your stove, please feel free to call or write us here at HearthStone, or contact your local HearthStone Dealer. We are here to serve you for as long as you own your stove.

If you are planning a trip to Vermont, we cordially invite you to visit us at our factory and see the stoves being built. Morrisville is located in North Central Vermont, On Route 100, 10 miles North of the Stowe resort area. We look forward to meeting you.

Thank you for choosing HearthStone. We trust that you will enjoy your stove.

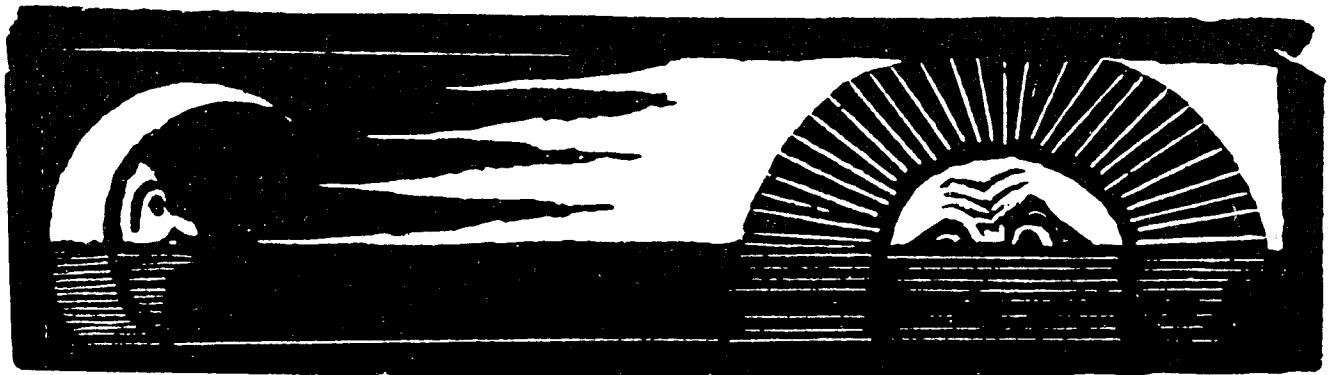

## Specifications

Maximum Heat Output .....	35,000 BTU's/Hr.(1)
Heat-Life .....	Up to 8 Hours on a single load of wood (2)
Maximum Combustion Efficiency .....	90%(1)
Size of Heated Area .....	Up to 8,000 cu. ft. (1)
Fuel Load .....	17.5 lbs. wood
Fuel Size .....	12" to 16" logs
Maximum Rate of Burn .....	8 lbs./Hr. (1)
Minimum Rate of Burn .....	2.2 lbs./Hr. (1)
Height .....	23½"
Width .....	23½"
Depth (including 4" ash lip) .....	24½"
Fireplace Door .....	6 7/8" x 13 ½"W
Stovepipe Size .....	6"
Recommended Chimney Size	
Metal Chimneys .....	6" inside diameter
Masonry Chimneys .....	8" x 8" square, 6" round
Flue Exit .....	Adjusts to top or rear pipe placement
Horizontal Flue Exit Center Line .....	20-½" H
Primary Combustion Control .....	Digital Electronic Air Control System or Manual Spindraft
Power Requirements	
(for electronic regulator) .....	110V AC (3 prong grounded outlet)
Wall-Mounted Thermostat .....	Standard Equipment
Wood Grate .....	Standard Equipment
Hearth Heat Shield .....	Standard Equipment
Weight .....	420 lbs.
Shipping Weight .....	440 lbs.
Soapstone Finish .....	Natural Buff-Grey Polished Green or Polished Brown
Cast Iron Trim Finish .....	Matte black or Porcelainized Brown Enamel

(1) Estimates based on latest HearthStone test results.

(2) Heat-Life is a trademark of The HearthStone Corporation, and is defined as thermal capacitance, or the quantity of heat stored. Used here, it refers to hours of usable heat obtainable from a single load of fuel. Area heated and duration of burn may vary from installation to installation.