



Champlain (Model 8301)

Gas-Fired Direct Vent Heater

Owner's Manual

Operation & Installation Guide

Read This Owner's Manual

Operate and Maintain This Gas Heater
According to This Instruction Manual.





Save These Instructions!



 **WARNING: FOLLOW THE INFORMATION IN THESE INSTRUCTIONS EXACTLY, IF NOT, A FIRE OR EXPLOSION MAY RESULT CAUSING PROPERTY DAMAGE, PERSONAL INJURY OR LOSS OF LIFE.**

 **WARNING: DO NOT STORE OR USE GASOLINE OR ANY OTHER FLAMMABLE VAPORS AND LIQUIDS NEAR THIS OR ANY OTHER GAS APPLIANCE.**

WHAT TO DO IF YOU SMELL GAS:





-  Do not try to light any appliance.
-  Do not touch electrical switches; do not use the phone in your building.
-  Immediately call your gas supplier from a phone outside the structure. Follow your gas supplier's instructions.
-  If you cannot reach your gas supplier, call the fire department or 911.

A qualified installer, service agency, or gas supplier must perform installation and service of this appliance. In the Commonwealth of Massachusetts, all installation of gas lines and gas fittings must be performed by a licensed gas fitter or licensed plumber.

 **AVERTISSEMENT: ASSUREZ-VOUS DE BIEN SUIVRE LES INSTRUCTIONS DONNÉ DANS CETTE NOTICE POUR RÉDUIRE AU MINIMUM LE RISQUE D'INCENDIE OU POUR ÉVITER TOUT DOMMAGE MATÉRIEL, TOUTE BLESSURE OU LA MORT.**

 **AVERTISSEMENT: NE PAS ENTRESPOSER NI UTILISER D'ESSENCE NI D'AUTRE VAPERURS OU LIQUIDES INFLAMMABLES DANS LE VOISINAGE DE CET APPRAREIL OU DE TOUT AUTRE APPAREIL.**

QUE FAIRE SI VOUS SENTEZ UNE ODEUR DE GAZ:

-  Ne pas tenter d'allumer d'appareil.
-  Ne touchez à aucun interrupteur. Ne pas vous servir des téléphones se trouvant dans le bâtiment où vous vous trouvez.
-  Appelez immédiatement votre fournisseur de gaz depuis un voisin. Suivez les instructions du fournisseur.
-  Si vous ne pouvez rejoindre le fournisseur de gaz, appelez le service des incendies.

L'installation et service doit être exécuté par un qualifié installer, agence de service ou le fournisseur de gaz.

Intentionally Blank

Information Sheet

Use this page to record all relevant information concerning the purchase, installation, and maintenance of your Champlain Model 8301 Direct -Vent heater. This information will facilitate servicing, purchase of replacement parts, and warranty claims (if necessary). Keep your original receipt in a safe place as proof of purchase.

Serial Number:		
Fuel type:	Natural Gas	Liquid Propane
Sold by:		Date of Purchase:
Address:		
Phone:		
E-mail		Website:
Installed by:		Date of Installation:
Address:		
Phone:		
E-mail		Website:
Gas Supplier:		
Address:		
Phone:		
E-mail		Website:

Read this Owner's Manual before installing or operating your Champlain. Retain this manual for future reference.

SERVICE RECORD

Date	Who Performed Work	Work Performed	Notes:

- | | |
|-----------------------|-----------------------|
| WHAT | WHEN |
| Firebox Cleaning..... | annually |
| Glass Cleaning..... | as needed |
| Gaskets..... | Replacement as needed |

Table of Contents

INTRODUCTION	4
WARNINGS, CAUTIONS, & SAFETY.....	4
SPECIFICATIONS	5
OWNER'S INFORMATION	6
LIGHTING INSTRUCTIONS	7
TO TURN OFF THE APPLIANCE.....	7
VARIABLE OUTPUT CONTROL.....	7
DAILY OPERATIONS	7
INSTALLER'S INFORMATION	8
CODES	8
UNPACKING AND INSPECTION.....	8
PACKING LIST	8
FIREBOX ACCESS.....	8
ITEMS REQUIRED FOR INSTALLATION	9
CLEARANCES TO COMBUSTIBLES.....	9
HEARTH REQUIREMENT/FLOOR PROTECTION	9
VENTING INFORMATION	11
VENTING COMPONENTS & CONFIGURATION	11
VENT CONNECTION	11
ACCEPTABLE DIRECT-VENT TERMINATION CAP ROOF LOCATIONS	13
VENT CONFIGURATION OPTIONS	13
VENT RESTRICTOR	16
GAS SUPPLY & CONNECTIONS	17
GAS CONNECTIONS	17
LOG PLACEMENT.....	18
INSTALLATION OF THE LOG SET.....	18
REMOVAL OF LOG SET.....	19
LIGHTING THE UNIT THE FIRST TIME	20
INITIAL ADJUSTMENTS.....	20
GAS CONVERSIONS	21
ROUTINE MAINTENANCE AND CARE.....	22
REPLACING THE GLASS	22
WIRING INSTRUCTIONS	23
PARTS LIST	24
RATING LABEL	25
TROUBLESHOOTING	26

INTRODUCTION

Congratulations on your purchase of Hearthstone's Champlain DV Model 8301 Gas-Fired Direct Vent heater. The Champlain DV will provide you with clean, efficient heat for years to come. Combustion air comes directly from the outside of your home to the sealed firebox system, eliminating the potential for annoying back drafts or other problems associated with depressurization common in modern, high efficiency homes.

The Champlain DV will also provide you with years of practical and convenient service. However, as with any gas appliance, the unit must be properly and safely installed and maintained by qualified service personnel to ensure safe and trouble-free operation.

READ THIS OWNER'S MANUAL

Operate and maintain this gas heater according to the instructions in this manual. For your safety, and years of trouble free operation, read this manual in its entirety. By following a few simple safety precautions and by performing minimal maintenance, the unit will remain appealing while providing years of quality performance.

WARNINGS, CAUTIONS, & SAFETY

FUEL GAS







This gas heater is designed to burn natural gas (NG) or with a conversion kit, liquid propane (LP). Never burn any fuel not intended for use with this unit. Never Burn Paper, Wood or Other Materials.

HOT SURFACES

Certain exposed surfaces of the Champlain DV will reach high temperatures during normal operation. Ensure you maintain clearances to combustibles, as specified in the "Clearances to Combustibles" section of this manual.

WARNING! USE ONLY A QUALIFIED SERVICE TECHNICIAN TO DO THE INSTALLATION, AND REPAIR. A QUALIFIED SERVICE TECHNICIAN MUST INSPECT THE APPLIANCE BEFORE USE, AND AT LEAST ANNUALLY. MORE FREQUENT CLEANING MAY BE REQUIRED DUE TO EXCESSIVE LINT FROM CARPETING, BEDDING MATERIAL, PETS, ETC. IT IS IMPERATIVE THAT THE CONTROL COMPARTMENTS, BURNERS, AND CIRCULATING AIR PASSAGES OF THE APPLIANCE ARE KEPT CLEAN AND FREE OF

OBSTRUCTIONS. (S'ASSURER QUE LE BRÛLEUR ET LE COMPARTIMENT DES COMMANDES SONT PROPRES. VOIR LES INSTRUCTIONS D'INSTALLATION ET D'UTILISATION QUI ACCOMPAGNENT L'APPAREIL.)

-  **WARNING: DO NOT OPERATE THIS APPLIANCE WITH THE GLASS, OR ANY PANEL REMOVED, CRACKED, OR BROKEN. DO NOT SUBJECT THE DOOR TO ABUSE, SUCH AS STRIKING OR SLAMMING SHUT. ONLY A LICENSED OR QUALIFIED SERVICE PERSON SHOULD REPLACE THE GLASS PANEL WHEN NECESSARY.**
-  **WARNING: DO NOT USE THIS APPLIANCE IF ANY PART WAS SUBMERGED IN WATER. IMMEDIATELY CALL A QUALIFIED SERVICE TECHNICIAN TO INSPECT THE HEATER AND TO REPLACE ANY PART OF THE CONTROL SYSTEM AND GAS CONTROL THAT WAS SUBMERGED. (NE SE SERVIR DE CET APPAREIL S'IL A ÉTÉ PLONGÉ DANS L'EAU, COMPLÈTEMENT OU EN PARTIE. APPELER UN TECHNICIEN QUALIFIÉ POUR INSPECTER L'APPAREIL ET REMPLACER TOUTE PARTIE DU SYSTÈME DE CONTRÔLE ET TOUTE COMMANDE QUI ONT ÉTÉ PLONGÉS DANS L'EAU.)**
-  **WARNING: DO NOT CONNECT THIS GAS APPLIANCE TO A CHIMNEY FLUE SERVING A SEPARATE SOLID-FUEL BURNING APPLIANCE. NEVER VENT THE GAS HEATER INTO OTHER ROOMS OR BUILDINGS. MASONRY CONVERSIONS KITS ARE AN ACCEPTABLE VENTING OPTION.**
-  **CAUTION: DUE TO HIGH TEMPERATURES, LOCATE THE APPLIANCE OUT OF TRAFFIC AND AWAY FROM FURNITURE, DRAPERIES, CLOTHING AND FLAMMABLE MATERIALS. ALERT CHILDREN AND ADULTS TO THE HAZARDS OF HIGH SURFACE TEMPERATURES SO THEY CAN AVOID BURNS TO SKIN OR PREVENT CLOTHING IGNITION. SUPERVISE YOUNG CHILDREN CAREFULLY WHEN THEY ARE IN THE SAME ROOM AS THE APPLIANCE. NEVER PLACE CLOTHING OR OTHER FLAMMABLE MATERIAL ON OR NEAR THE APPLIANCE. (SURVEILLER LES ENFANTS. GARDER LES VÊTEMENTS, LES MEUBLES, L'ESSENCE OU AUTRES LIQUIDES À VAPEUR INFLAMMABLES LOIN DE L'APPAREIL.)**
-  **FIRE HAZARD: DO NOT STORE OR USE GASOLINE OR OTHER FLAMMABLE VAPORS OR LIQUIDS IN THE VICINITY OF THIS APPLIANCE.**
-  **REPLACE ANY SHIELD, DOOR, OR SAFETY SCREEN COMPONENT REMOVED FOR SERVICING PRIOR TO OPERATING THE UNIT.**

SPECIFICATIONS

Testing Agency: Intertek Testing Services NA, Inc. (ITS)

Listed: Direct Vent Gas Heater

Model: Champlain DV Model 8301

Tested to: ANSI Z21.88b – 2008/CSA 2.33b - 2008

Certified for Canada, CSA P.4.1

Approved for Mobile Home Installation

Certified for use by:

Board of State Examiners of Plumbers and Gasfitters
100 Cambridge Street, Room 1511
Boston, Massachusetts 02202

Manufactured and Warranted by:

Hearthstone Quality Home Heating Products, Inc.
317 Stafford Ave.
Morrisville, VT 05661-8695, USA
www.hearthstonestoves.com

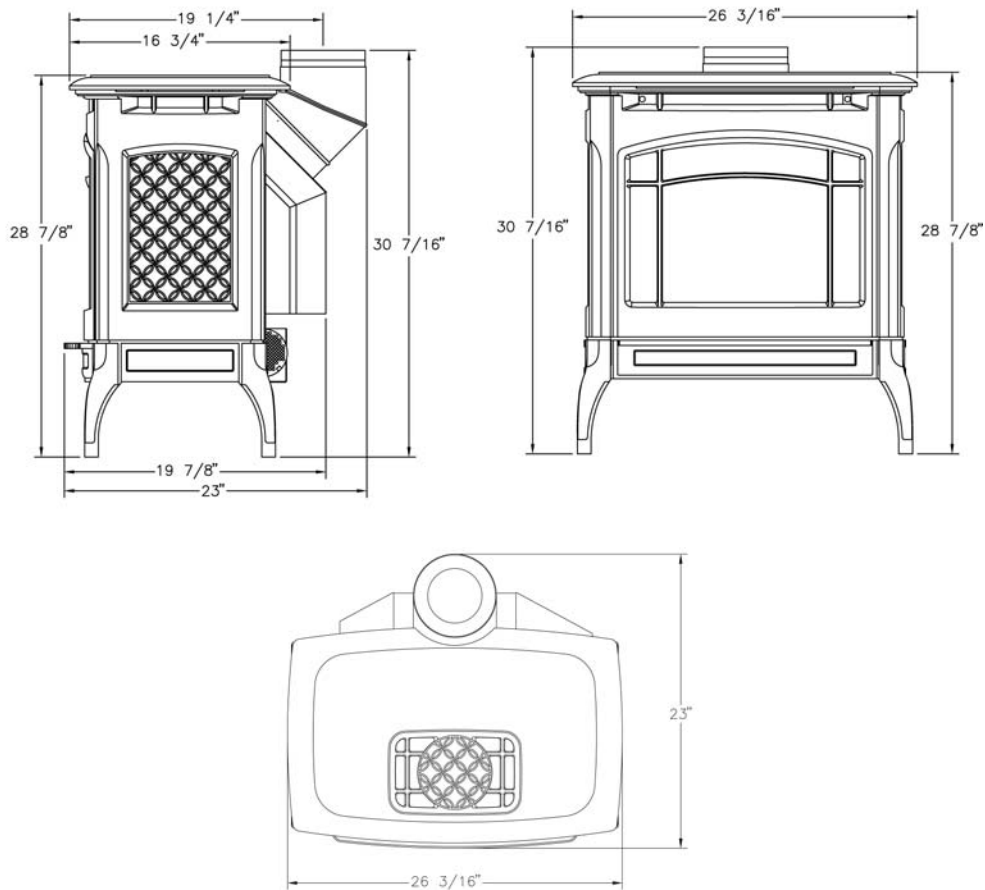

Figure 1 – Champlain DV Dimensions

Specification	NG	LP
Input rating (Btu/hr) 0-2000 ft	35,000	35,000
Input rating (Btu/hr) 2000-4500 ft	35,000	33,300
Orifice size DMS 0-2000 ft	32	49
Orifice size DMS 2000-4500 ft	32	50
Man. press.-LO setting (in.w.c./kPa)	1.2/0.3	3.3/0.8
Man. press.-HI setting (in.w.c./kPa)	3.5/0.87	10.0/2.48
Inlet press.-LO setting(in.w.c./kPa)	5.0/1.24	11.0/2.88
Inlet press.-HI setting(in.w.c./kPa)	7.0/1.74	13.0/3.22
Minimum input rating rating (Btu/hr)	21,500	20,400
Maximum output (Btu/hr) 0-2000 ft	25,600	25,600

OWNER'S INFORMATION

The installation must conform with local codes or, in the absence of local codes, the current National Fuel Gas Code, ANSI Z223.1 (NFPA 54), or CAN/CGA B149 Installation Code. *(Installer l'appareil selon les codes ou règlements locaux, ou, en l'absence de tels règlements, selon les Codes d'installation CAN/CGA-B149.)*

Service Caution

Replace any components of the stove removed for servicing before operating. If you believe your Champlain is not performing properly, immediately discontinue operation until the unit is inspected and approved for operation by qualified service personnel. Prior to servicing the unit, turn the gas supply to the valve off. Ensure the unit is cool before servicing and cleaning.

Do not use any components other than those approved by Hearthstone Quality Home Heating Products, Inc., otherwise all warranties are void. **Do not substitute components!**

FIRE HAZARD

Do not store, or use gasoline, or other flammable vapors or liquids near this appliance. The Champlain should be located out of traffic, and away from furniture, draperies, clothing, and other flammable materials.

SHOCK HAZARD

(If equipped with accessory blower) The accessory blower is equipped with a three-prong (grounding) plug for protection against shock hazard and must be plugged directly into a properly grounded three-prong receptacle. Do not cut, or remove, the grounding prong from the plug.

HOT SURFACES

Certain exposed surfaces of the Champlain will reach high temperatures during normal operation. Clearances to combustibles must be maintained, as specified in the "Clearances To Combustibles" section of this manual. Due to high temperatures, the appliance should be located out of traffic and away from furniture, draperies, clothing, and other flammable materials. Alert children and adults to the hazards of high surface temperatures and that they must stay away to avoid burns to skin or possible clothing ignition.



Supervise young children carefully when in the same room as the appliance. Do not place clothing or other flammable material on or near the appliance. *(Surveiller les enfants. Garder les vêtements, les meubles, l'essence ou autres liquides à vapeur inflammables loin de l'appareil.)*

Clean the area around, under, and behind the unit on a regular basis to prevent the accumulation of dust and lint.

 **WARNING! DO NOT OPERATE THIS APPLIANCE WITH THE FRONT GLASS REMOVED, CRACKED, OR BROKEN. REPLACEMENT OF GLASS SHOULD BE DONE BY A LICENSED OR QUALIFIED SERVICE PERSON. ONLY OPEN FRONT FOR ROUTINE SERVICE. DO NOT SLAM, OR STRIKE THE GLASS.**

 **WARNING! A QUALIFIED SERVICE TECHNICIAN SHOULD PERFORM THE INSTALLATION, AND ANY REPAIRS. A QUALIFIED SERVICE TECHNICIAN MUST INSPECT THE APPLIANCE BEFORE USE, AND AT LEAST ANNUALLY. MORE FREQUENT CLEANING MAY BE REQUIRED DUE TO EXCESSIVE LINT FROM CARPETING, BEDDING MATERIAL, PETS, ETC. IT IS IMPERATIVE THAT THE CONTROL COMPARTMENTS, BURNERS, AND CIRCULATING AIR PASSAGES OF THE APPLIANCE ARE KEPT CLEAN AND FREE OF OBSTRUCTIONS. (S'ASSURER QUE LE BRÛLEUR ET LE COMPARTIMENT DES COMMANDES SONT PROPRES. VOIR LES INSTRUCTIONS D'INSTALLATION ET D'UTILISATION QUI ACCOMPAGNENT L'APPAREIL.)**

LIGHTING INSTRUCTIONS

1. Set the on/off/T-stat switch or thermostat to the off position.
2. Unplug the blower accessory, if so equipped.
3. Push in and turn gas control knob clockwise to "OFF". *(If not previously lit, the knob should be in this position.)*
4. Wait (5) five minutes to clear out any gas. If you then smell gas, STOP! *Smell all around the appliance area for gas. Be sure to smell next to the floor because some gases (LPG) are heavier than air and will settle on the floor. If you smell gas immediately, follow the **What To Do If You Smell Gas!** warning on the cover of this Manual. If you do not smell gas, go to the next step.*
5. Turn gas control knob counterclockwise to "PILOT".
6. Push in control knob all the way and hold in. Immediately light the pilot with the gas lighter (push in and "click" the piezoelectric spark igniter button several times until lit). Continue to hold the control knob in for about 20 seconds after the pilot is lit. Release the knob and it will pop back out. Pilot should remain lit. If the pilot goes out, repeat the operation.
 -  If knob does not pop out when released, stop and immediately call a qualified service technician or gas supplier.
 -  If the pilot will not stay lit after several tries, turn the gas control knob "OFF" and call a qualified service technician or gas supplier.
7. Turn gas control knob counterclockwise to "ON".
8. Select "ON" or "T-STAT" position on the on/off/t-stat switch.
9. Shut the gas control valve access door.
10. Plug in the blower accessory, if so equipped.

11. Set thermostat to "ON" and set the desired temperature setting.

Normally, if the "T-STAT" position was selected, the main burner is cycled on and off by the Thermostat or the "on", "off" switch located on the bottom of the Thermostat body.

TO TURN OFF THE APPLIANCE

Turn the gas control knob clockwise to "OFF" position, and shut off the gas supply to the valve if shutting the unit off for the non-heating season. This will improve the overall efficiency of the unit as the heat from the pilot is wasted in the summer. Follow the lighting instructions outlined on this page when putting the unit back into service.

VARIABLE OUTPUT CONTROL

The gas control valve is equipped with a variable output control. This control varies the *rate* of heat produced by the unit by varying the gas pressure to the main burner tube.

DAILY OPERATIONS

The Champlain gas-fired heater is easy to operate. The Champlain comes with a standard thermostat. Optional remote, or programmable thermostats are available for purchase from your local Hearthstone dealer. The desired room temperature is maintained with a properly adjusted and installed thermostat. By adjusting the variable output control located on the gas control valve, the rate of heat output is varied to meet the heating requirements of the season. Choosing a low flame setting will result in longer burn cycles at a reduced output, while choosing a high flame setting will result in a shorter, hotter burn cycle. Through trial and error, the homeowner can select the optimum flame size for their setting, and application. Also available is a optional variable speed blower.

INSTALLER'S INFORMATION

CODES

Adhere to **all local codes** or, in their absence, obtain the latest edition of THE NATIONAL FUEL GAS CODE ANSI Z223.1 (NFPA 54) or CAN/CGA B149 Installation Code from:

AMERICAN NATIONAL STANDARDS INSTITUTE, INC.
1430 BROADWAY
NEW YORK, NY 10018
www.ansi.org

OR

NATIONAL FIRE PROTECTION ASSOCIATION, INC.
BATTERY MARCH PARK
QUINCY, MA 02269
www.nfpa.org

The appliance, when installed with a blower, must be electrically connected and grounded in accordance with local codes or, in the absence of local codes, with the current NFPA 70-National Electrical Code or CSA C22.1-Canadian Electric Code.

A manufactured home (or mobile) OEM installation must conform to the Manufactured Home Construction and Safety Standard, Title 24 CFR, Part 3280 (U.S.) or Standard for Manufactured Home Installation, ANSI/NCBCS A225.1 or Standard for Gas Equipped Recreational Vehicles and mobile Housing, CSA Z240.4.CAN/SCA Z240 MH (Canada). *(Installer l'appareil selon les codes ou règlements locaux, ou, en l'absence de tels règlements, selon les Codes d'installation CAN/CGA-B149.)*

For installations from 610-1370 meters (2000-4500 ft.) the orifice sizes (DMS) for natural and propane gas are 32 and 52 respectively. See data plate for additional information. For high altitude installations consult the local gas distributor or the authority having jurisdiction for proper rating methods. If the installer must convert the unit to adjust for varying altitudes, the information sticker must be filled out by the installer and adhered to the appliance at the same time of conversion. *(Cet appareil est équipé pour des altitudes comprises entre 0 et 2000 pieds (0-610 m) seulement.)*

UNPACKING AND INSPECTION

Unpack and Inspect for Damage

Hearthstone packages the Champlain to withstand normal shipment without damage. However, damage can still occur during transit, so take care to inspect for damage when unpacking and installing

the unit. If you detect any damage, or a missing part, immediately contact your dealer.

 **Do not install or put into service a damaged or incomplete heater.**

The unit should appear square and level, with the sheet metal parts smooth and free of bends or dents. Enameled cast iron should be free of chips or cracks. If you find visible or concealed damage, contact your dealer.

PACKING LIST

1-Champlain DV Gas-fired Heater containing:
6-Decorative Fiber Logs
1-Pan Burner
1-Owner's Manual and Warranty
1-Bag Charcoal Embers
1-Bag Platinum Bright Embers
2-Decorative Caps
1-Accessory box containing:
1-Top Grille
1-Thermostat with Thermostat Wire
2-Extension control Knobs
1-LP Conversion kit

FIBER LOG SAFETY INFORMATION

The decorative fiber logs supplied with the Champlain are located in the firebox. Always use great care when handling the decorative fiber logs, as they are fragile and subject to damage and breakage. If the decorative fiber logs supplied with the Champlain are damaged, they must be replaced. Contact your local Hearthstone dealer for replacement parts. Do not replace fiber logs, or the embers, with any materials not approved by Hearthstone.

FIREBOX ACCESS

To open the firebox:

1. Remove the two upper front screws (located in the grill of the front) that hold the cast façade onto the unit. **(These screws ship on the unit for transit purposes only and are removed during installation.)**
2. Open the valve access door by pulling the ash lip out off the magnet and down. Allow the door to swing down completely.

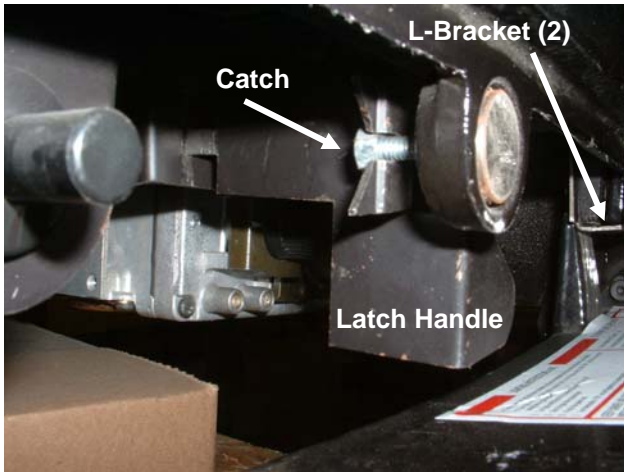

Figure 2: Façade Spring Latch Detail

3. Grasp the handle of the spring latch, located in the center of the opening, pull out towards you and then move the handle to the right to disengage the catch, then release tension on the latch - be careful not to drop the front as the latch is unfastened. Be careful not to chip the enamel when handling the front façade.
 4. Grasp the bottom of the façade, lift it up slightly and out off the L-brackets. Lower the façade and move it away from the unit - set aside
 5. To remove the glass, reach over the firebox, and under the front grill. With a flat screwdriver, pry the retaining clips up. There are two separate clips. Be careful, when you lift the last one, as it will free the glass and frame from the unit.
- Note:** The two screws holding the top of the front on are for shipping purposes only. Once the stove has arrived at the final destination, remove these two screws and replace them with the two decorative caps provided with the unit.
6. To re-install – reverse the outlined steps above.

ITEMS REQUIRED FOR INSTALLATION

External regulator (for LP)	Phillips head screwdriver
Code Compliant Piping	7/16-inch wrench
Pipe sealant approved for use with LP	Other parts as required by local code
Manual shutoff valve	*Safety Glasses
Sediment trap (page 17)	*Gloves
Tee joint	
Pipe wrench	

*Recommended

CLEARANCES TO COMBUSTIBLES

Always maintain clearances around the air openings in the stove. This allows for adequate ventilation. (As shown in Figures 3, through 6.) The corner clearance for the Champlain is 2", measured from the edge of the top castings to the adjacent wall.

HEARTH REQUIREMENT/FLOOR PROTECTION

You can install the Champlain on any non-combustible surface, or wood floor. For placement of the Champlain on carpeting, vinyl tile, or other combustible materials, you must install the appliance on any noncombustible or wood panel extending the full width and depth of the appliance. Installations must meet all codes.

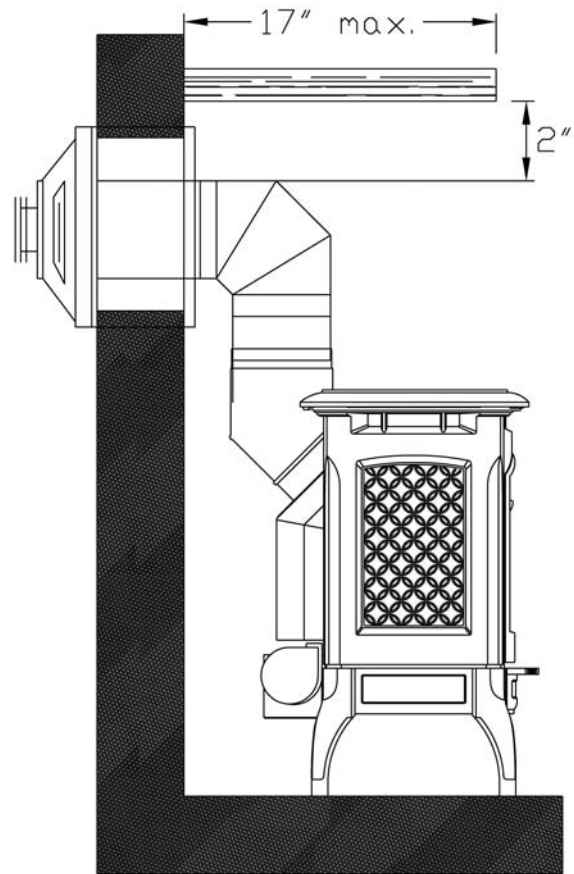

Figure 3: Mantle Clearance Horizontal Vent

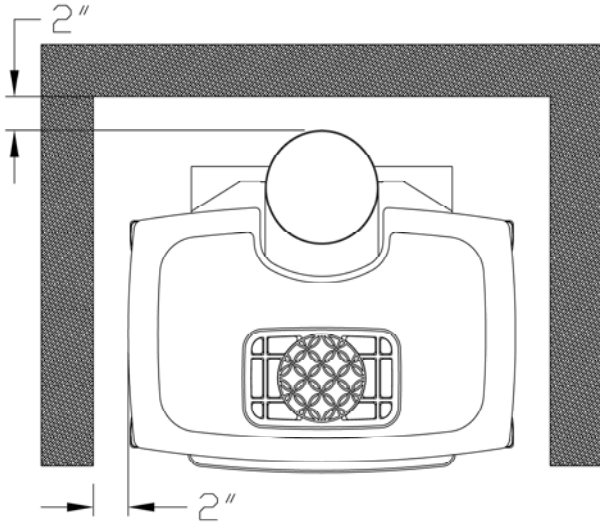

Figure 4: Wall Clearances Horizontal Vent

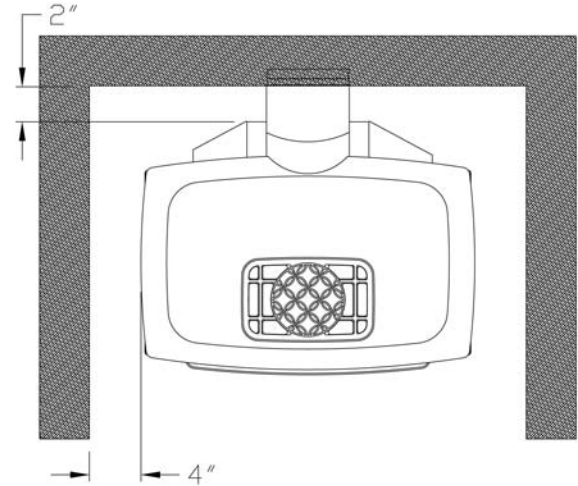

Figure 6: Snorkel Wall Clearances

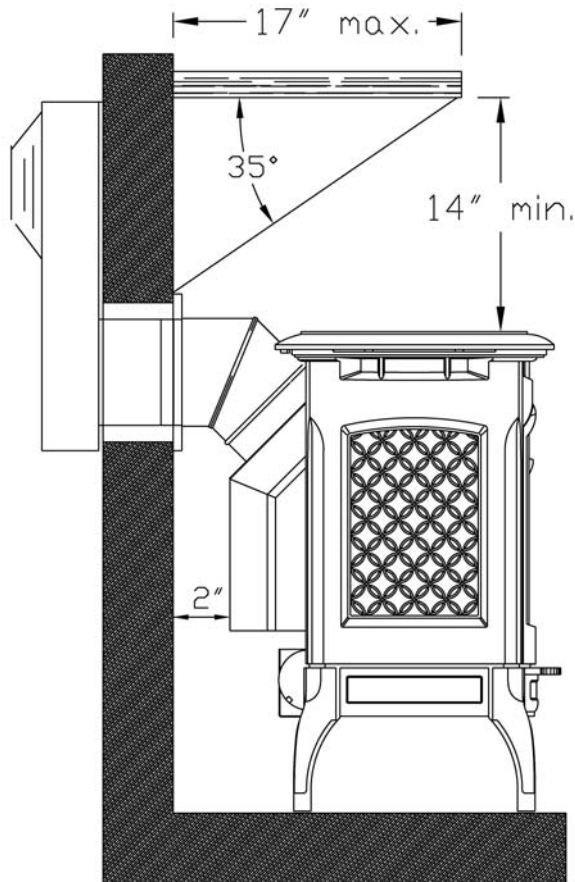





Figure 5: Snorkel Mantle Clearance

-  **CONDITIONALLY APPROVED FOR PURCHASED MOBILE HOME INSTALLATION. THIS APPLIANCE MAY BE INSTALLED IN AN AFTERMARKET PERMANENTLY LOCATED, MANUFACTURED (OR MOBILE) HOME, WHERE NOT PROHIBITED BY LOCAL CODES.**
-  **THIS APPLIANCE IS ONLY FOR USE WITH THE TYPE OF GAS INDICATED ON THE RATING PLATE. THIS APPLIANCE IS NOT CONVERTIBLE FOR USE WITH OTHER GASES, UNLESS A CERTIFIED KIT IS USED, AVAILABLE THROUGH YOUR LOCAL HEARTHSTONE DEALER.**
-  **CET APPAREIL PEUT ÊTRE INSTALLÉ DANS UN MAISON PRÉFABRIQUÉE (MOBILE) DÉJÀ INSTALLÉE À DEMEURE SI LES RÉGLEMENTS LOCAUX LE PERMETTENT.**
-  **CET APPAREIL DOIT ÊTRE UTILISÉ UNIQUEMENT AVEC LES TYPES DE GAS INDIQUÉS SUR LA PLAQUE SIGNALÉTIQUE. NE PAS L'UTILISER AVEC D'AUTRES GAS SAUF SI UN KIT DE CONVERSION CERTIFIÉ EST INSTALLÉ**

VENTING INFORMATION

There are many configurations of vent installations for your stove. Please review the following pages for the venting installation that works best for you.

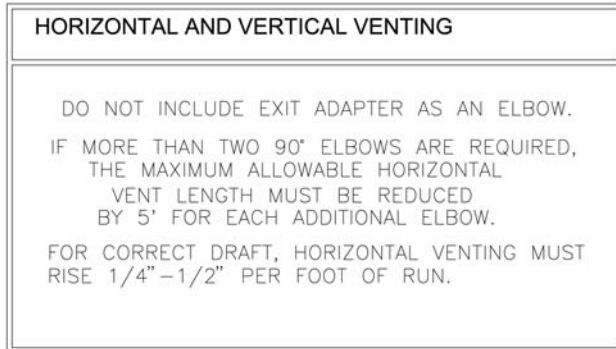

Figure 7: General Venting Rules

VENTING COMPONENTS & CONFIGURATION

Do not vent the Champlain jointly with any other solid fuel or gas appliance. Vent the stove directly to the outside of the building using a proper termination as listed in this manual. The only types of venting pipe approved for use with your Champlain Direct-Vent stove are those listed in this manual. The venting configuration diagram is shown in *Figure 13*. After determining the proper venting configuration for your stove, select the vent system that will accommodate your installation.

 **CAUTION: ENSURE NO WIRING OR PLUMBING IS IN THE CHOSEN LOCATION.**

 **CAUTION: DO NOT RECESS VENTING TERMINATIONS INTO A WALL OR SIDING.**

Note: If you need further direction for installation, please refer to the venting instructions provided with the venting components.

VENT CONNECTION

The Champlain Direct Vent Model 8301 is approved for installation only with the vent connecting

components listed in this manual. Use the following instructions along with the pipe manufacturer's instructions to complete the installation.

The starter collar is factory installed. Install the rest of the vent system according to the manufacturer's instructions.

SPECIFIED VENTING MANUFACTURERS

This heater is approved for installation only with the venting components provided by manufacturers listed on this page.

Simpson Dura-Vent, Inc.
P.O. Box 1510
Vacaville, CA 95696-1510 800-835-4429

American Metal Products (*AmeriVent*)
8601 Hacks Cross Rd.
Olive Branch, MS 38654 800-423-4270

Selkirk Corporation
1301 W. President George Bush Hwy, Suite 330
Richardson, TX 75080-1139 800-992-8368

Security Chimneys International Ltd (*Secure Vent*)
2125 Monterey, Laval, Quebec
Canada, H7L 3T6 450-973-9999

ICC, Inc.
400 J-F Kennedy, St. Jerome, Quebec
Canada, J7Y 4B7 450-565-6336

Metal-Fab, Inc.
P.O. Box 1138
Wichita, Kansas 67201 316-943-2351

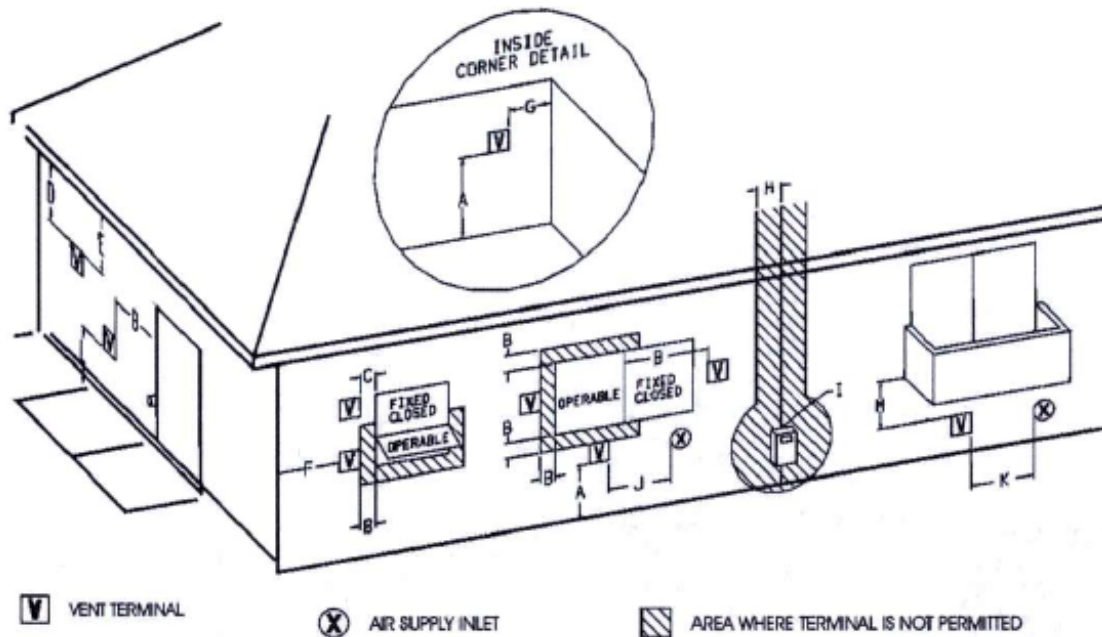

Figure 8: Termination Location & Clearances

A = Clearance above grade, veranda, porch, deck, or balcony: 12 inches (30cm) minimum.

B = Clearance to window or door that may be opened: **Min. 9 inches U.S./12 inches (30cm) CAN. We recommend 12 in, minimum to prevent condensation on the window.

C = Clearance to permanently closed window: **Min. 9 inches, U.S./12 inches (30cm) CAN.

We recommend 12 in. minimum to prevent condensation on the window.

D = Vertical clearance to ventilated soffit located above the termination within a horizontal distance of 2 feet (60cm) from the center line of the termination: 18 inches (46cm) minimum.

E = Clearances to unventilated soffit: 12 inches (30cm) minimum.

F = Clearance to outside corner: **Min. 9 inches, U.S./12 inches (30cm) CAN. We strongly recommend 12 inches, particularly where windy conditions prevail.

G = Clearance to inside corner: **Min. 6 inches, U.S./12 inches (30cm) CAN. We strongly recommend 12 inches, particularly where strong winds prevail.

H = *Not to be installed within 15 feet (4.5m) above a meter/regulator assembly within 3 feet (91cm) horizontally from the center line of the regulator.

I = Clearance to service regulator vent: 3 feet (91cm)

J = Clearance to non-mechanical air supply inlet to building or the combustion air inlet to any other appliance: 12inches (30cm) minimum.

K = Clearance to a mechanical air supply inlet: **Min. 3 feet (91cm) above if within 10 feet horizontally, U.S./6 feet (1.83m) CAN minimum.

L = ¹Clearance above paved sidewalk or a paved driveway located on public property: 7 feet (2.1m) minimum.

M = ²Clearance under veranda, porch, deck, or balcony: 12 inches (30cm) minimum.

**In accordance with CSA B149 Installation codes.*

***In accordance with the current ANSI Z223.1/NFPA 54, National Fuel Gas Code. Note: Local Codes and Regulations may require different clearances.*

¹A vent shall not terminate directly above a sidewalk or driveway which is located between two single family dwellings and serves both dwellings

*²Only permitted if veranda, porch, deck or balcony, is fully open on a minimum of two sides beneath the floor.**

ACCEPTABLE DIRECT-VENT TERMINATION CAP ROOF LOCATIONS

The vent/air intake termination clearances above the high side of an angled roof as follows:

Roof Pitch	Feet	Meters
Flat to 6/12	1	0.3
7/12 to 9/12	2	0.6
10/12 to 12/12	4	1.2
13/12 to 16/12	6	1.8
17/12 to 21/12	8	2.4

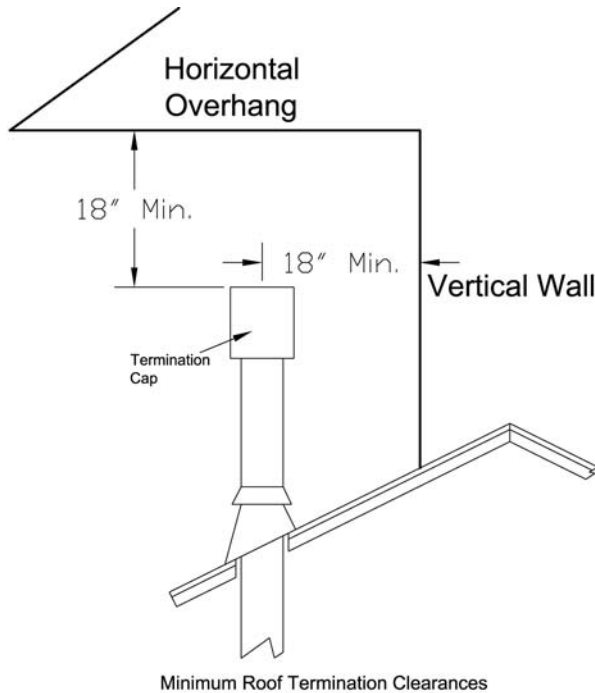

Figure 9: Termination Cap clearances

APPROVED VENTING SYSTEM COMPONENTS

(The following are components that are available, BUT NOT necessary for all installations)

90° Elbow	Vertical Vent Cap
45° Elbow	36" Snorkel
6" Straight	Vinyl Siding Standoff 4" x 6 5/8"
9" Straight (Simpson only)	
12" Straight	Round Ceiling Support
24" Straight	Thimble Covers
36" Straight	Wall thimble
48" Straight	Horizontal Vent Cap
11"-14 5/8" Adjustable Pipe	

CHIMNEY LINER SYSTEM

Direct-Vent Chimney Liner Termination Kit
Chimney Liner Flex
Co-Linear Flex Connector
Axial to Co-Linear Appliance Connect (Masonry approved, not to exceed 16' measured from the stove top)

- If the vent system is disassembled for any reason, it must be reinstalled per the instructions provided for in the initial installation or in this manual.

VENT CONFIGURATION OPTIONS

I. STANDARD HORIZONTAL INSTALLATION

Kit #93-65000)

- Note:** Install the 45° elbow over the outer collar. Place the elbow so that the twist lock end is pointing straight up. Install the 2' pipe section into this elbow by fully inserting it, and turning approximately ¼ turn clockwise until the two sections are fully locked. Install the 90° elbow in similar fashion with the opening pointing to the rear.
- Note:** Ensure there is no Wiring or Plumbing in the chosen wall location.

Move the stove and pipe assembly back until the 90° elbow is flush to the wall. Ensure the 2' vertical pipe is still parallel to the wall. Draw a circle around the pipe where it touches the wall. Use the center of this circle as the center point of the 10" x 10" square wall pass through.

Cut and frame the wall for the vent pipe. Install the horizontal vent termination on the outside of the wall. Ensure both of the retaining straps extend through the wall pass through to the inside of the wall.

Before attaching the vent termination to the outside of the house, run a bead of non-hardening mastic around the outside edges, between the vent termination and the wall. The arrow on the end cap should point up. Secure the cap to the wall with the appropriate screws.

Put the adjustable (11"-14") pipe into the horizontal vent cap, (the vent pipe must extend into the horizontal vent cap a minimum of 1 ¼"). Move the stove and vent pipe into position, insert the adjustable (11"-14") pipe into the 90° elbow, twist lock it.

Secure the straps from the horizontal vent termination to the interior pipe with two sheet metal

screws, keeping the screws as close to the wall thimble as possible. Bend or cut the excess strapping so the thimble cover will fit properly. Screw the thimble cover to the wall.

🔥 The adjustment range for wall thickness for this configuration is 3”min to 9”max.

II. FIREPLACE VENTING INSTALLATIONS

- 40' maximum system height (without offsets)
- 14' maximum offset (refer to Figures 10 - 12)
- Maximum rise to run = 1 to 5 (refer to Figures 9-13)
- The termination must meet the requirements outlined in Figure 8 and Figure 9.

Champlain or Santa Fe Vertical Venting Using:	
- A Chimney as an Air Inlet Adaptor - A Co-linear Adaptor - A Co-axial Adaptor	
V (FT)	H (FT)
10' MIN. —————	1.5' MAX.
40' MAX. —————	1.5' MAX.
$H1 + H2 = H (FT)$	
V + H = MAXIMUM ALLOWABLE VENT LENGTH FOR CORRECT DRAFT, HORIZONTAL VENTING MUST RISE 1/4" - 1/2" PER FOOT OF RUN.	
RESTRICTOR PLATE IN POSITION (1) FULLY OPEN DO NOT INCLUDE EXIT ADAPTER AS AN ELBOW.	

Figure 10: Vertical Venting Rules

III. VERTICAL TERMINATION VENTING CONFIGURATIONS

- 40' maximum system height (without offsets)

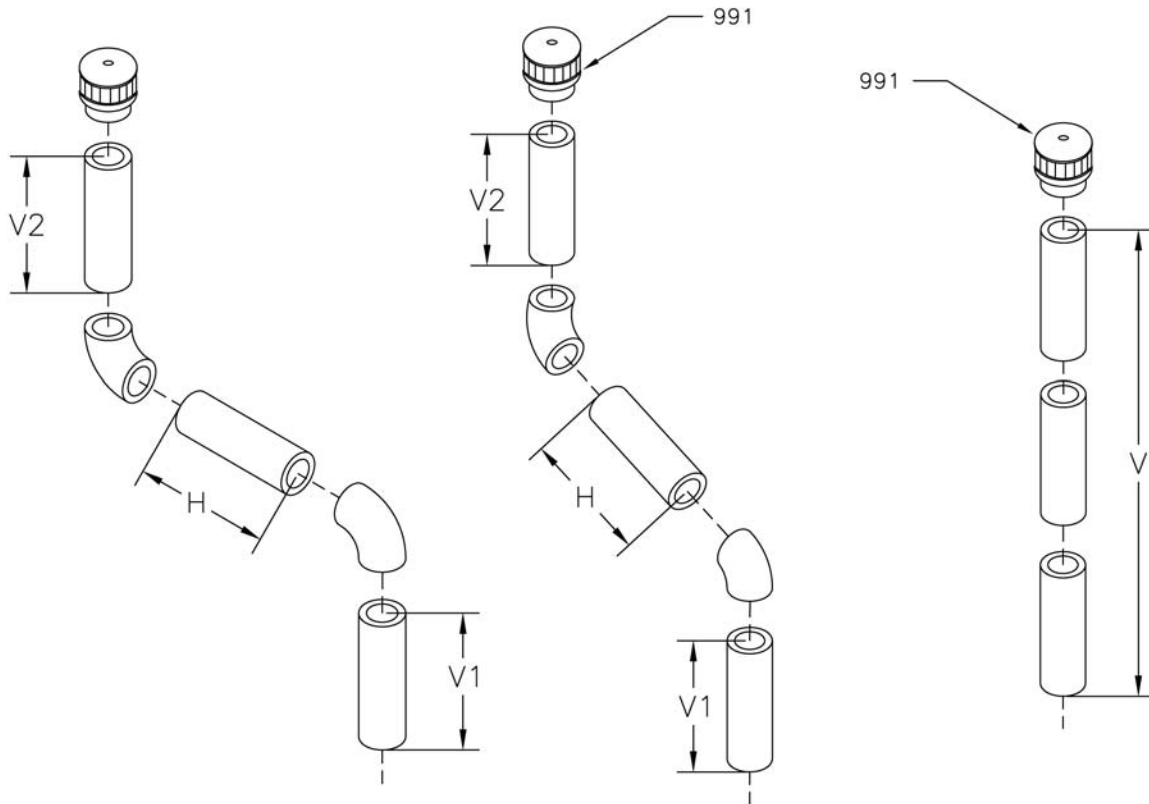

Figure 11: Approved DV Vertical Co-Axial Termination Configurations

IV. HORIZONTAL TERMINATION VENTING CONFIGURATIONS

- A minimum of 24" rise is required (with or w/o offsets)
- 40' maximum system height (without offsets)
- Maximum rise to run = 1 to 5
- The termination must meet the requirements outlined in *Figure 8 & 9*. Use a vinyl siding Stand off when installing against vinyl siding.

- Horizontal sections require a 1/4" rise every 12" of horizontal run.
- For each 90° elbow after the second, remove 5' from horizontal run.
- Use with snorkel termination 45" maximum horizontal run.

CHAMPLAIN VERTICAL VENTING USING:
 -A CHIMNEY AS AIR INLET ADAPTER
 -A CO-LINEAR ADAPTER
 -CO-AXIAL ADAPTER

V (FT)	H (FT)
10' MIN. — — — — 1.5' MAX.	1.5' MAX.
30' MAX. — — — — 1.5' MAX.	1.5' MAX.

H1 + H2 = H (FT)
 V + H = MAXIMUM ALLOWABLE VENT LENGTH

FOR CORRECT DRAFT, HORIZONTAL VENTING MUST RISE 1/4" - 1/2" PER FOOT OF RUN.

DO NOT INCLUDE EXIT ADAPTER AS AN ELBOW.

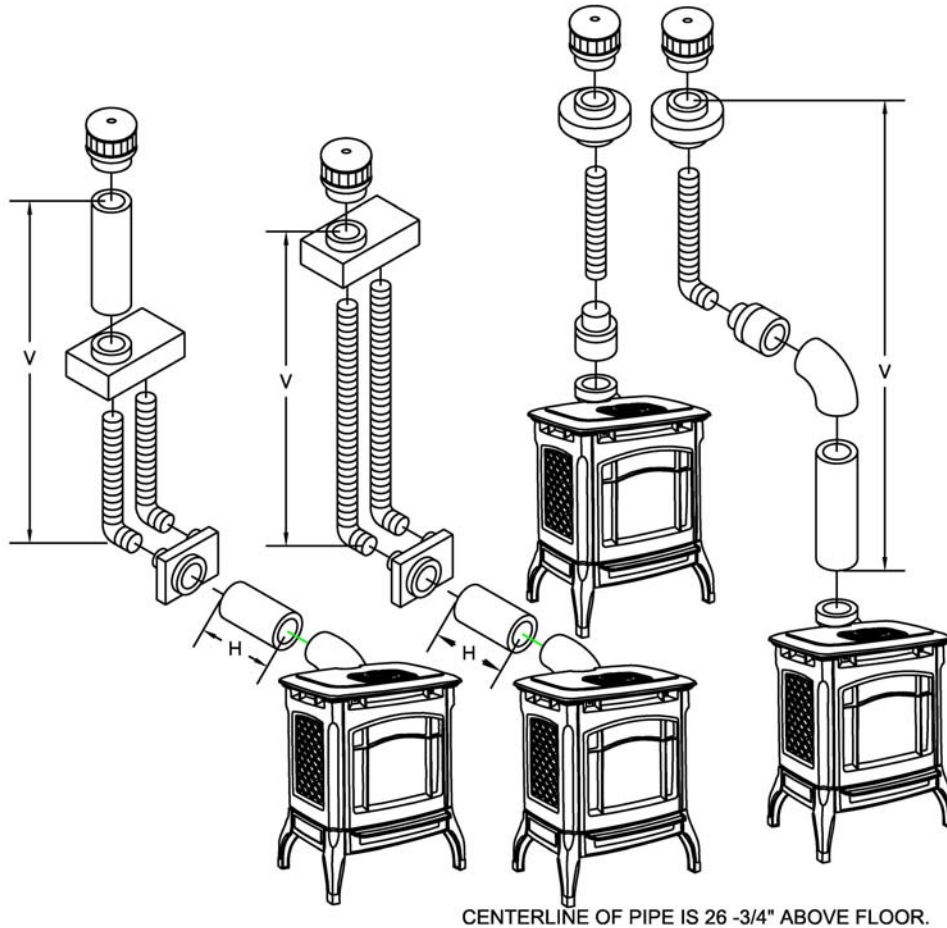

Figure 12: Approved DV Venting Alternate Configurations for Vertical Termination

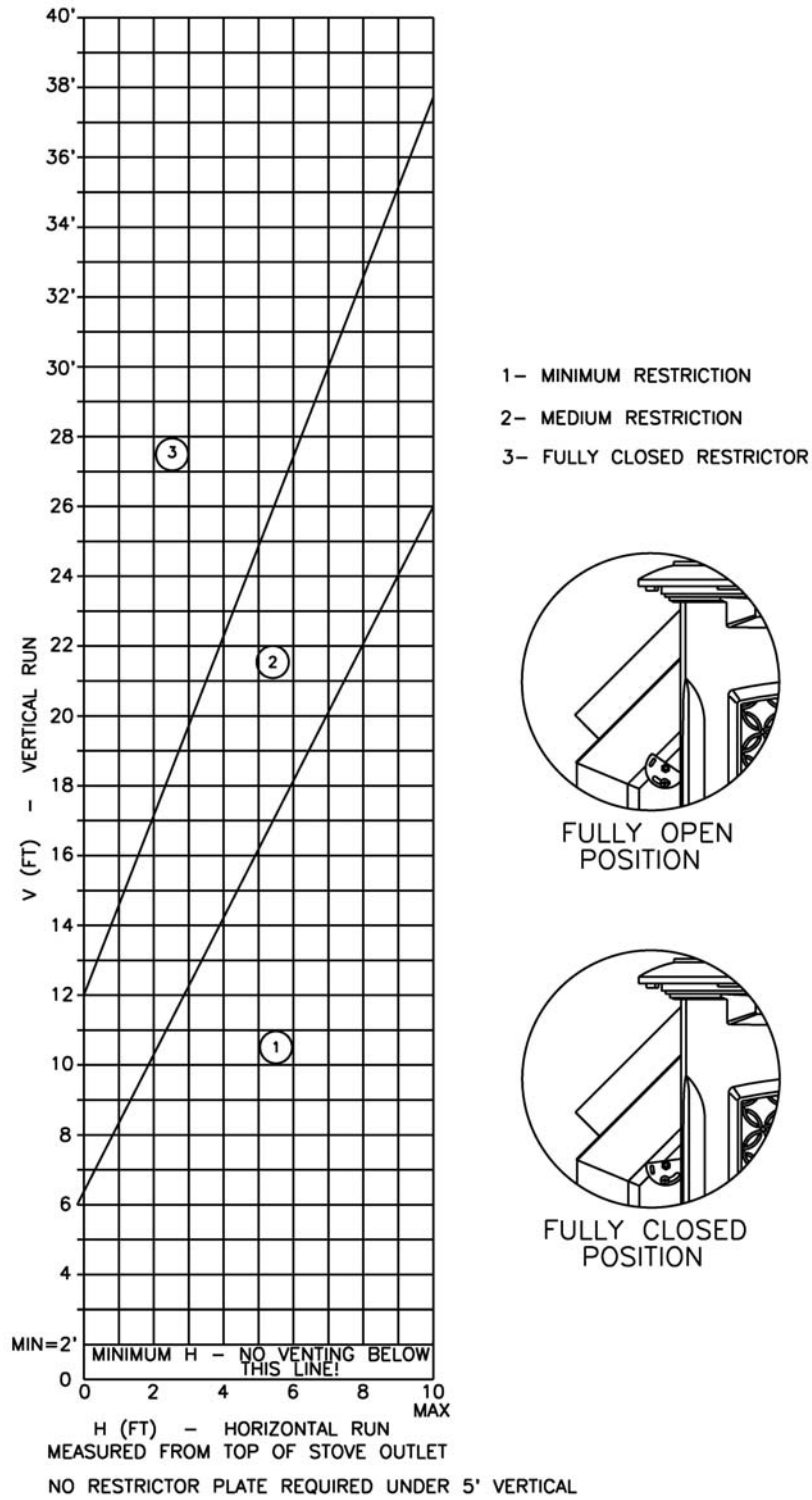

Figure 13: Venting Configuration and Restrictor Settings

VENT RESTRICTOR

To adjust your restrictor for maximum flame appearance, loosen the phillips head screw and spin

the locator, found on the rear left side of the stove (Refer to figure 13 above)

GAS SUPPLY & CONNECTIONS

GAS CONNECTIONS

The gas supply line connection is made to the Champlain's gas control valve located under the unit on the left side using a 3/8" NPT fitting. The pipe must be sized to provide sufficient gas supply to meet the maximum demand of the unit. The supply line must include a manual shut-off valve and union so that the unit can be disconnected for servicing.

Use of a dedicated sediment trap (see figure 14) is required by code, and by Hearthstone. **Damage to components caused by the lack of a sediment trap is not covered by warranty.**

Once connected to the gas supply, the gas inlet pressure, and manifold gas pressure, must be tested. The gas control valve has built in pressure taps for test gauge connections. The supply line pressure must be tested to ensure it meets the minimum pressure for the type of fuel in use (NG or LP).

Pressure Measurements: To measure the gas pressures, connect a manometer to the gas inlet tap (6) and manifold pressure tap (7) in Figure 15.

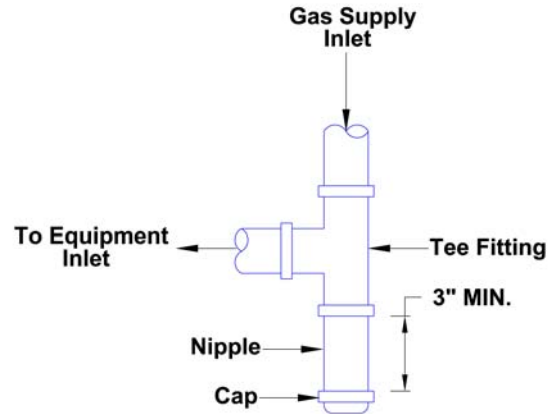

Figure 14: Typical Sediment Trap

GAS PRESSURE ADJUSTMENT

A qualified technician must connect the heater to the gas supply, and leak test the unit before it is approved for use. Consult all applicable codes. The appliance, and its main gas valve, must be isolated from the gas supply piping system by closing its individual manual shutoff valve during any pressure testing of the gas supply piping system at test pressures equal to or greater than 1/2 psig (3.5kPa).

VALVE DESCRIPTION

- | | | |
|--|------------------------------|-----------------------------------|
| ① Gas cock knob | ⑥ Inlet pressure test point | ⑪ Flange securing screw holes |
| ② Manual HI-LO adjustment or pressure regulator adjustment | ⑦ Outlet pressure test point | ⑫ Additional valve mounting hole |
| ③ Pilot adjustment | ⑧ Main operator | ⑬ Alternative TC connection point |
| ④ Thermocouple connection | ⑨ Pilot outlet | ⑭ Thermoelectric unit |
| ⑤ Mounting for piezo & bracket | ⑩ Main gas outlet | |

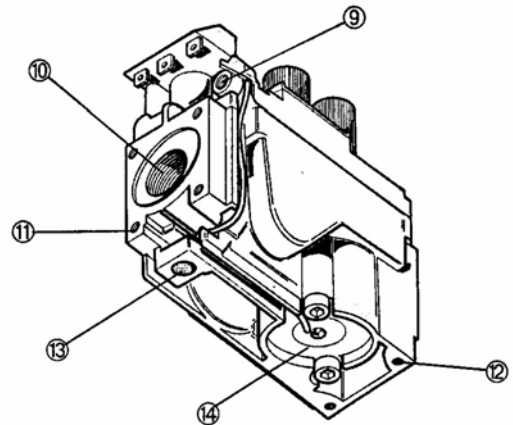
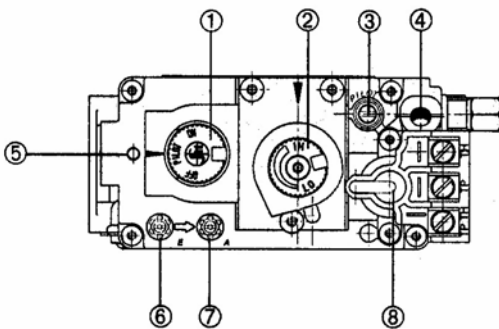

Figure 15: Gas Control Valve Detail

LOG PLACEMENT

Place only the decorative fiber log set supplied with the unit in the firebox. This log set is specifically designed for the provided pan burner. Do not use any other type of fiber logs, wood logs, or other materials in the firebox. If the original log set is damaged, or broken, contact your Hearthstone dealer for replacement. The decorative fiber log set is durable, however, they will break easily if subjected to rough or improper handling.

Position the log set exactly as shown in order to obtain a pleasing flame pattern and efficient combustion. Incorrect log placement can cause carbon build-up; excess thermal stress on the log set and stove parts, reduced efficiency, and high levels of carbon monoxide. If the log set does not fit into the firebox exactly as outlined, contact your dealer for assistance.

INSTALLATION OF THE LOG SET

 **CAUTION: DO NOT PLACE EMBERS NEAR THE PILOT.**

(Refer to the figures in this section)

1. If not already opened, follow the instructions for firebox access on page 8.
2. Remove the packaging material around the log set assembly. Be careful not to damage the log set when unpacking. Observe the 5 mounting "posts", A, B, C, D, and E.

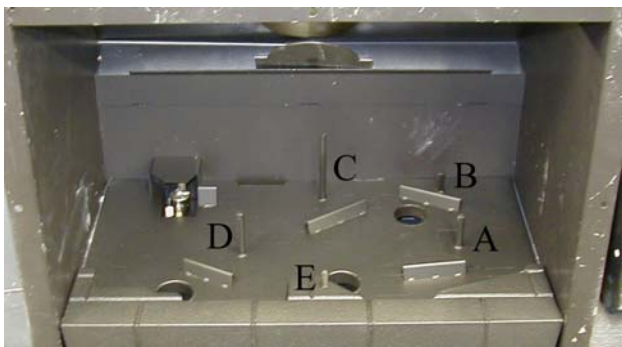

3. Gently slide the Y-shaped Log (1) onto pins A and C, as shown next.



4. Gently slide the longer, "half" log (2) onto pin D. Be sure to position the rear of the log in front of the pilot assembly and against the left side of the firebox as shown below.



5. Gently slide the shortest of the "half" logs (3) onto pin B as shown below.



6. Gently slide the medium length of the "half" logs (4) onto pin E as shown next.



7. Gently slide the split log (5) onto pins C and D as shown below.



8. Place the right end of the curved log (6) onto the protruding pin C on log 1, and rest its left end on log 2 as shown below. Push this log back until the curve is against the baffle.



9. Spread the Charcoal Embers evenly across the front portion of the Pan Burner, one layer high. You may or may not need to use all of the Charcoal Embers. Keep the rest for use in the future. Do not drop the embers into the burner holes. Locate and open the bag of Platinum Bright Embers. Pull apart small pieces of the wool and sprinkle over the Charcoal Embers

randomly. This wool will glow brightly once the unit is running.



10. Replace the glass frame by sliding it down the face of the firebox and pushing the top back. Slide the two clips back down to hold the frame in place.

REMOVAL OF LOG SET

CAUTION! LOG SET AND CHARCOAL EMBERS WILL RETAIN HEAT AND CAN BE VERY HOT, IF PREVIOUSLY LIT! ALLOW AT LEAST 1 HOUR AFTER PILOT LIGHT IS TURNED OFF BEFORE HANDLING.

To remove the log set, follow the Installation of Log Set instructions in the reverse order.

CAUTION! FRAGILE! HANDLE LOG SET AND CHARCOAL EMBERS WITH CARE.

LIGHTING THE UNIT THE FIRST TIME

SMOKE AND FUMES WARNING

When lit for the first time, the Champlain will emit some smoke and odors. This is normal “off-gassing” of the paints and oils used in the manufacturing, and assembly of the unit. Open windows to vent the room if necessary. The off gassing and fumes will subside after the first 10 to 20 minutes of operation.

Once the Champlain in place and connected as described previously, the unit is ready to be lit for the first time. Hearthstone tests each Champlain before shipment, so ignition should take place without failure.

PILOT LIGHT

The Champlain has a piezoelectric spark igniter (the red or black push button located next to the gas control valve behind the valve access door), which ignites the pilot light by means of a spark at the pilot light assembly. Do not attempt to light the unit with a match or by any means other than the piezoelectric spark.

PILOT ADJUSTMENT

The pilot light is preset by Hearthstone and should not need adjustment. The pilot light flame must be large enough to engulf the thermopile and thermocouple located next to the pilot, but not so large as to create excessive noise or consume excessive gas (*refer to figure 17*). However, it can be adjusted by means of the pilot light adjustment screw located on the gas control valve (*see Figure 15*). Open the ash lip door to access the pilot adjustment screw. Note that the pilot flame must engulf the thermopile so that the thermopile can generate sufficient milli-voltage (325 to 500-mv) to power the millivolt gas control valve

Before lighting, smell, or use a gas detector all around the appliance area to check for gas leaks. Be sure to test near the floor because some gases (LPG) are heavier than air and will settle on the floor. If you detect gas, check for leaks.

🔥 WARNING! THE CONTROL HAS AN INTERLOCK DEVICE. IF THE STOVE WAS RECENTLY BURNING, IT WILL NOT RELIGHT IMMEDIATELY. AFTER SHUTTING OFF ALL GAS FLOW, THE PILOT BURNER WILL NOT RELIGHT UNTIL THE THERMOCOUPLE HAS COOLED, RELEASING THE ELECTROMAGNET (APPROX. 60 SEC.). THE GAS CONTROL KNOB IS DESIGNED TO OPERATE BY HAND. DO NOT USE ANY TOOLS DURING THIS OPERATION.

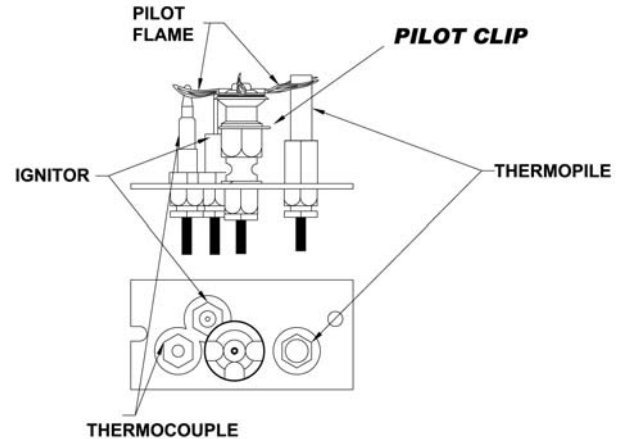

Figure 16: Pilot Assembly Detail

INITIAL ADJUSTMENTS

AIR SHUTTER ADJUSTMENTS

The air shutter, located at the lower rear center of the stove, is adjustable while the stove is burning by loosening the set nut on the adjusting bolt located on the lower rear left of the stove. Light the unit and run at highest flame setting for at least 10 minutes for the unit to come up to temperature and to allow the flame to stabilize. The set nut will be hot and should not be touched with bare skin. Use only metal tools for this adjustment. Loosen the set nut using a 7/16" wrench and turn the bolt to adjust the flame pattern. Turn the bolt clockwise to open the air shutter, and counterclockwise to close the shutter. When the flame pattern is correct, tighten the set nut without letting the bolt turn. The air shutter is factory set and only a qualified gas technician should make adjustments.

🔥 Note: Very little movement substantially changes the burn and flame patterns. Air shutter adjustment cannot correct for all conditions; an adjustment must be made to the gas supply pressure if necessary. Supply line/manifold gas line pressure adjustments must be performed by qualified service personnel. Do not attempt to complete any part of the installation or adjustment of this unit unless technically qualified to do so.



Figure 17: TYPICAL FLAME PATTERN

GAS CONVERSIONS

Each Champlain stove is factory set for use with Natural Gas. However, conversion is easy for use with LP, and visa versa. Follow the instructions provided with the included conversion kit.

🔥 ONLY A QUALIFIED GAS TECHNICIAN SHOULD DO THE CONVERSION.

For checking, and properly adjusting, the manifold pressure, refer to the *Gas Connection section on page 17* of this manual. ***Leak test before, and after, lighting the stove.***

Fill out the label provided on back of the stove. Verify the input rate of the heater by checking the manifold pressure. If the manifold pressure is correct, then the input rate is also correct. Ensure to check the manifold pressure and properly adjust the pilot and main burner flames if necessary.

ROUTINE MAINTENANCE AND CARE

The Champlain requires minimal routine maintenance and care. The unit should always be cool and off when cleaned, or serviced.

Once a year the unit and venting system should be inspected by qualified service personnel to ensure that they are clean, prevent the accumulation of dust, lint and other debris, free of obstruction, safe and in good working condition. To clean the firebox, set the switch to the "OFF" position, and turn off the gas to the gas control valve.

When the unit is cool, open the front door and carefully remove the decorative fiber log set taking care not to damage the logs or chip the enameled cast iron. Clean the pan burner, and carefully vacuum the entire surface of the log set. Take care to thoroughly vacuum the ports (slots) on the top of the pan burner.

With the decorative fiber logs out of the firebox, fasten the door shut and briefly light the unit according to *lighting instructions* described on *Page 7*. Check to ensure a flame is burning from each burner port. The pilot flame should be large enough to engulf the thermocouple and thermopile. Turn the unit off by setting the switch to "Off", and turning off the gas control valve. **Allow the unit to cool.** Check and clean any burner ports that are not burning, or not burning properly. Clean the burner ports using a soft brush or vacuum cleaner. Adjust the pilot flame height if necessary.

Complete the cleaning procedure by carefully placing the log set back in the firebox as described on *Page 18*. Re-install the glass assembly and front façade. Turn on the gas, light the unit, and check for proper operation.

 **WARNING! DO NOT USE ABRASIVES WHEN CLEANING THE GLASS.**

REPLACING THE GLASS

Order kit 93-58015 (complete glass assembly with frame). To replace the front glass, first shut the pilot light off. Refer to the Firebox Access instructions on page 8 to remove the front façade casting and glass assembly.

1. If the glass is severely broken, first pull the broken fragments of glass away from the firebox using heavy-duty gloves.
2. Then remove the glass frame and clean up any remaining glass fragments.
3. Carefully install the new glass with frame onto the firebox.
4. Replace the door reversing the steps used for removal.

 **WARNING! DO NOT USE SUBSTITUTE MATERIALS. USE ONLY PARTS SUPPLIED BY HEARTHSTONE THROUGH AN AUTHORIZED HEARTHSTONE DEALER.**

 **CAUTION! DO NOT CLEAN THE GLASS WHILE THE UNIT IS HOT.**

Wiring Instructions

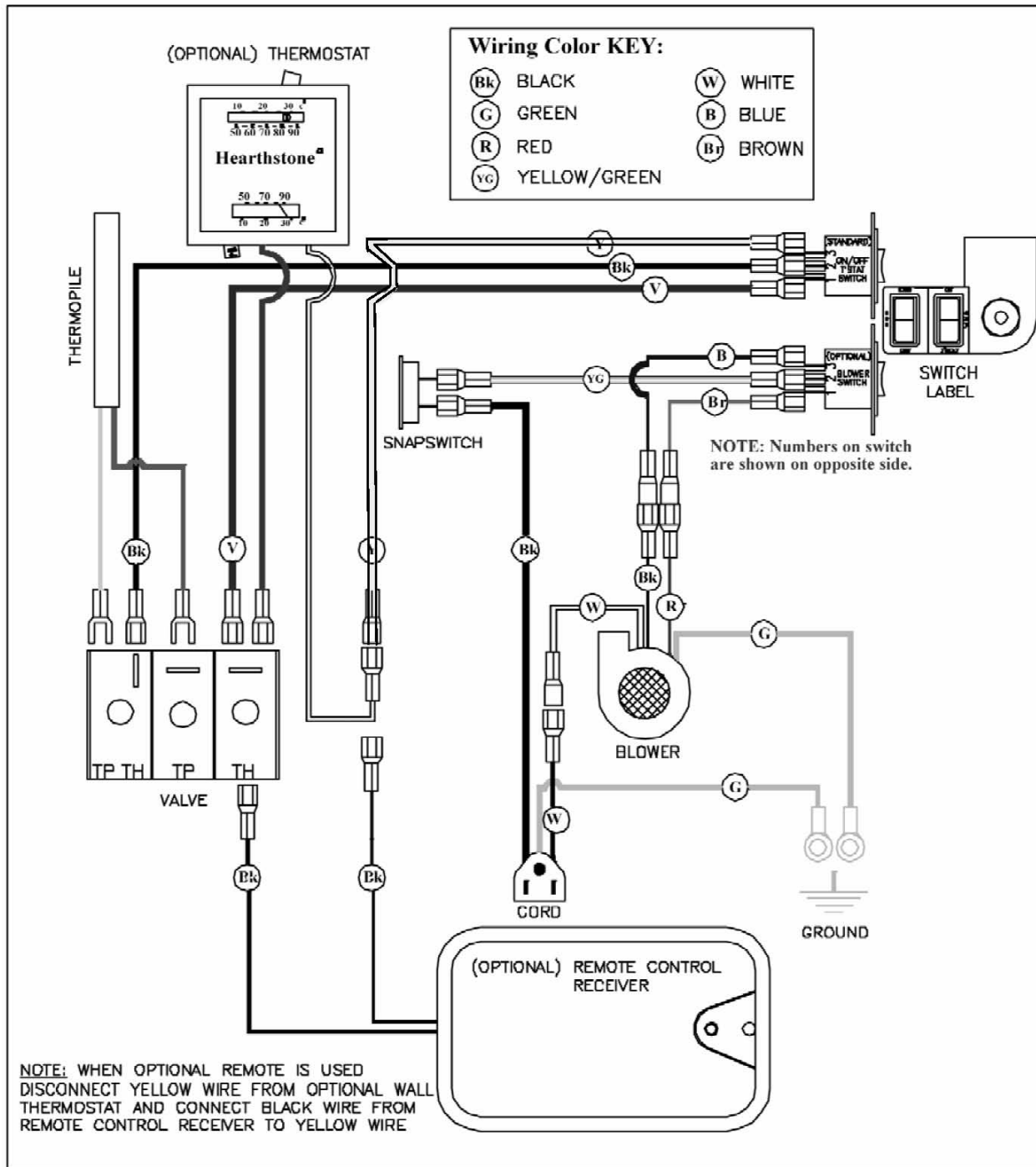

Figure 18: Champlain 8301 Wiring Detail

CAUTION: LABEL ALL WIRES PRIOR TO DISCONNECTION WHEN SERVICING CONTROLS. WIRING ERRORS CAN CAUSE IMPROPER AND DANGEROUS OPERATION. VERIFY PROPER OPERATION AFTER SERVICING.

ATTENTION: AU MOMENT DE L'ENTRETIEN DES COMMANDES, ÉTIQUÉTEZ TOUS LES FILS AVANT LE DÉBRANCHEMENT. DES ERREURS DE CÂBLAGE PEUVENT ENTRAÎNER UN FONCTIONNEMENT INADÉQUAT ET DANGEREUX.)

PARTS LIST

PART #	DESCRIPTION	PART #	DESCRIPTION
2310-020	BRICK PANEL FRONT	5301-050	HEATSHIELD: REAR, RIGHT, CHA/SAN
23X0-440	FRONT	5301-060	RESTRICTOR PLATE ASSEMBLY
23X0-845	TOP GRILL	5301-070	SHUTTLE POSITION INDICATOR
2310-850	HEAT EXCHANGER BASE	5301-080	OUTLET RESTRICTOR CLIP
2310-860	HEAT EXCHANGER	5701-925H	STARTER COLLAR
2310-240	EXHAUST BAFFLE	7200-349	ORIFICE: BURNER, LP, #49 SPUD
3030-028	GLASS	7211-390	3-WAY PILOT HOOD (W/ CLIP)
3110-057	LOW DENSITY DOOR ROPE 3/8"	7211-009	PILOT GAS TUBE
3160-075	HEAT EXCHANGER FLAT ROPE 1/4"	7211-320	VALVE (NG)
3160-080	GLASS TAPE 3/4"	7211-370	PILOT ASSEMBLY (NG)
3160-150	FIREBOX/AIR HEAT EXCHANGER GASKET	7210-103	PIEZO IGNITER
3160-152	PILOT GASKET	7211-017	GAS LINE 3/8 DIAMETER
3160-157	GASKET 6"	7211-221	BURNER ASSEMBLY
3160-300	PRIMARY AIR CONTROL GASKET	7211-430	IGNITER ELECTRODE
3170-150	PLATINUM BRIGHT EMBERS	7211-470	THERMOCOUPLE
5300-066	PIEZO BRACKET	7211-601	BOTTOM RIGHT LOG
5300-090	SECONDARY AIR PLENUM	7211-602	REAR RIGHT LOG
5300-112	RESTRICTOR PLATE	7211-603	FRONT CENTER LOG
5300-114	RESTRICTOR PLATE ROD	7211-604	BOTTOM LEFT LOG
5301-010	FIREBOX: CHA/SAN	7211-605	REAR TOP LOG
5301-030	CONTROL: PRIMARY AIR ASSEMBLY	7211-606	FRONT TOP LOG
5301-040	HEATSHIELD: REAR, LEFT, CHA/SAN	7211-517	EMBERS: PYROTEK, 4 OZ.

Accessories available:

BLOWER KIT # (93-57010)
 REMOTE CONTROL ON/OFF # (90-56912)
 REMOTE CONTROL THERMOSTAT # (90-56914)

 **WARNING! DO NOT SUBSTITUTE MATERIALS.**

For replacement parts, or for information about parts or service, contact your authorized Hearthstone retailer. For the name of the authorized retailer nearest to you, visit our website at www.hearthstonestoves.com.

RATING LABEL

MODEL # 8301-
SERIAL #



MODEL NAME: CHAMPLAIN DIRECT VENT GAS FIREPLACE HEATER
LISTED: VENTED GAS FIREPLACE HEATER
TESTED TO: ANSI Z21.88-2002 CSA 2.33-M02, CAN/CGA-2.17-M91

CERTIFIED FOR CANADA/HOMOLOGUE POUR LE CANADA
ALSO FOR MOBILE HOME INSTALLATION

DO NOT OPERATE WITH GLASS REMOVED OR BROKEN.

FUEL TYPE:	■ NG	■ LP
INPUT RATING (Btu/hr) 0-2000 ft	35,000	35,000
INPUT RATING (Btu/hr) 2000-4500 ft	35,000	33,300
ORIFICE SIZE (DMS) 0-2000 ft	32	49
ORIFICE SIZE (DMS) 2000-4500 ft	32	50
MANIFOLD PRESSURE - LO SETTING (in. W.c./kpa)	1.2/0.3	3.3/0.8
MANIFOLD PRESSURE - HI SETTING (in. W.c./kpa)	3.5/0.87	10.0/2.48
INLET PRESSURE (in.w.c./kpa)	5.0/1.24	11.0/2.88
MINIMUM INPUT RATING (btu/hr)	21,500	20,400
MAXIMUM OUTPUT (btu/hr) 0-2000 ft	25,600	25,600

This appliance must be installed in accordance with the local codes, if any, if not, follow the National Fuel Gas Code, ANSI Z223.1 or Canadian Installation Codes, CAN/CGA B149. (Installer l'appareil selon les codes ou réglemets locaux, ou, en l'absence de tels réglemets, selon les Codes d'installation CAN/CGA-B149.)

WARNING: Improper installation, adjustment, alteration, service or maintenance can cause injury or property damage. Refer to the owner's information manual provided with this appliance. For assistance or additional information consult a qualified installer, service agency or the gas supplier. (L'AVERTISSEMENT: L'installation inconvenante, ajustement, modification, service ou entretien peut causer le dommages de propriété ou blessure. Référez au manuel d'information de propriétaire fourni cet appareil. Pour l'assistance ou information supplémentaire consulte un qualifiée installateur, agence de service ou le fournisseur de gaz.)

MINIMUM CLEARANCES TO COMBUSTIBLES	
EDGE OF TOP TO: CEILING	14" / 356mm
EDGE OF SIDE TO: BACKWALL	2" / 50 mm
EDGE OF SIDE TO: SIDEWALL	4" / 100 mm

ELECTRICAL RATING:
115 VOLTS, LESS THAN 2.0A

Several Optional kits are available through HearthStone or your local HearthStone dealer. A blower assembly may be used (kit # 93-57010), two different remote controls (kit #90-56912 & kit #90-56914) are optional as well.

This appliance is only for use with the type of gas indicated on this rating plate and may be installed in an aftermarket, permanently located, manufactured (mobile) home where not prohibited by local codes. See owner's manual for details. This appliance is not convertible for use with other gases, unless a certified kit is used. If the vent air intake system is disassembled for any reason, reinstall per the instructions provided with the initial instructions. This vented gas fireplace heater is not for use with air filters.

VENTED GAS FIREPLACE HEATER - NOT FOR USE WITH SOLID FUEL.



MANUFACTURED BY: HearthStone, MORRISVILLE, VERMONT 05661

Date of Manufacture

2004	2005	2006	Jan	Feb	Mar	Apr	May	Jun	Jul	Aug	Sep	Oct	Nov	Dec
■	■	■	■	■	■	■	■	■	■	■	■	■	■	■

DO NOT REMOVE OR COVER THIS LABEL

MADE IN USA

3300-566

TROUBLESHOOTING

Symptom	Possible Cause	Corrective Action
1. Pilot will not light.	A. Insufficient gas pressure, air in the pilot line, or dirty or kinked gas line.	A. Using the piezo sparker, try to light the pilot. If it will not light, check the inlet gas pressure.
	B. Pilot orifice plugged.	B. Clean or replace the pilot assembly.
	C. Defective or misaligned electrode at pilot.	C. If a match lights a pilot, check the electrode gap and location. Should be a 1/8" gap in the flame area.
	D. Defective igniter.	D. Check for a good connection between igniter and electrode. Check wire insulation. If properly connected and no spark, replace igniter.
	E. After sitting for "off" season (summer), pilot assembly may be dirty.	E. Clean or replace the pilot assembly.
2. Pilot will not stay lit after carefully following lighting instructions.	A. Low or too high gas pressure	A. Check for proper inlet pressure for the gas being used.
	B. Faulty connections.	B. Measure voltage between valve body and solder connection on the rear of the valve (where the blue wire connects). It should be no less than 7 mV.
	C. Defective thermocouple.	C1. Ensure that the thermocouple connection at the gas valve is tight. C2. Check thermocouple output using milli-volt meter. Disconnect from valve and read voltage across wire ends. If the reading is less than 15 mV, replace the pilot assembly. C3. If burning NG, check pilot flame to see that it is impinging on the top of the thermocouple. Clean or replace pilot for maximum flame impingement.
	D. Pilot dirty or plugged.	D. Clean or replace the pilot assembly.

Symptom	Possible Cause	Corrective Action
3. Pilot burning, no gas to main burner, valve knob in the "ON" position, thermostat and/or on/off/t'stat switch in the "ON" position.	A. Thermostat switch or wires defective.	A. Check thermostat/wiring for proper connections. Place jumper wire across terminals at thermostat. If burner comes on, replace defective thermostat. If not OK, place jumper across thermostat wires at gas valve. If burner comes on, tighten connections, or replace faulty wires.
	B. Thermopile may not be generating sufficient voltage.	B. Check thermopile output, using a milli-volt meter. If the optional on/off kit has not been installed, take the readings across generator terminals of the gas valve. TPTH and TP). With the on/off kit, take the readings across TH and Terminal block (which corresponds to #3 on the switch). Milli-volt reading should be greater than 325 mV. If not, replace the pilot assembly. If the meter reading is OK, but the burner does not come on, replace the gas valve.
	C. Plugged burner orifice.	C. Remove and check burner orifice, clean or replace. Note: do not use any metal cleaning device, as this may damage the orifice.
4. Pilot and burner come on, but go out after some warm-up.	A. Inconsistent, of insufficient flame on thermopile.	A. Adjust pilot flame size and assure that the flame is aimed directly at the thermopile.
	B. Insufficient gas pressure.	B. Check line pressure to ensure that the correct inlet pressure is present for the type of gas being used. If propane pressure is inconsistent, check for water condensation at the regulator.
5. Frequent pilot outage problem.	A. Pilot flame may be too low or blowing, (high), causing the pilot safety to drop out.	A. Clean and/or adjust the pilot flame for maximum impingement on the thermopile and thermocouple.
6. Glass fogs	A. A normal result of gas combustion.	A. After the heater has warmed up, the glass should clear.
7. Blue Flames	A. A normal result during the first 20 minutes.	A. Flames should begin to turn more yellowish after 20 minutes of burning.
		B. If the blue color stays; adjust the air shutter for a proper burn.

Symptom	Possible Cause	Corrective Action
<p>8. Floating flames, lazy ill-defined, quiet flames, which roll around, sometimes completely off of the port, sometimes with overly, yellow tips. Possible sooting. Usually accompanied by the odor of aldehydes.</p>	<p>A. Potentially dangerous incomplete combustion due to incorrect air to fuel ratio (lack of combustion air or excessive fuel delivery i.e. excessive gas pressure, overrating of appliance). B. Incorrect air intake/exhaust flow system. Causes may be: B1. Blocked burner. B2. Blocked primary air B3. Blocked secondary air inlets</p>	<p>A. Check the appliance input rate and reduce if necessary. The air intake/exhaust flow system may be too restrictive or blocked (the rate at which the exhaust leaves [draft] determines the rate at which the combustion air is delivered). Poor draft results in insufficient air delivery or a restricted exhaust. Correct air intake/exhaust flow system. B1. Clear ports. B2. Clear obstructions. B3. Clear obstructions. C. If gas pressures are correct and the flames stay the same, adjust the air shutter for a proper burn.</p>
<p>9. Burner flashback. Air-gas mixture ignites inside the burner near the orifice, usually creating a roaring noise like a blowtorch. The problem is an imbalance of gas flow velocity and burning speed pattern.</p>	<p>A. Excessive. B. Burner input underrated. C. Valve leak if flashback occurs with burner valve in off position. D. Improper gas pipe size.</p>	<p>A. Adjust the air shutter for a proper burn. B. Check input rate. Check input pressure using a manometer. Confirm correct gas pressure at house meter or tank (call gas company). Confirm burner orifice size. C. Replace valve. If above corrections do not eliminate flashback, replace burner. D. Correct plumbing.</p>
<p>10. Delayed ignition (makes a sudden "whoosh" noise as the burner lights). This is a buildup of gas prior to ignition. This is more prevalent with propane (LP) fuel.</p>	<p>A. Incorrect air-to-fuel ratio. A1. Primary air incorrect. A2. Burner ports plugged. B. Improper log placement.</p>	<p>A1. Adjust the air shutter for a proper burn. A2. Open ports to allow for proper travel of flames. B. Reposition logs to eliminate interference with flame travel.</p>

WARRANTY REGISTRATION

The Original Purchaser can complete their warranty registration on our website at www.hearthstonestoves.com, or send a completed and signed Warranty Registration Form, which is enclosed in the Gas Stove warranty packet, to the following address:

Hearthstone Quality Home Heating Products, Inc.
Warranty Department
317 Stafford Avenue
Morrisville, VT 05661

 **NOTE: SENDING IN THE SIGNED WARRANTY REGISTRATION FORM IS *NOT REQUIRED* AS A CONDITION OF WARRANTY COVERAGE OR HEARTHSTONE'S PERFORMANCE.**