



Manchester

(Model 8330)
Pellet Stove

OWNER'S MANUAL Operating Instructions



Please read this entire manual before installation and use of this pellet fuel burning room heater. Failure to follow these instructions could result in property damage, bodily injury, or even death.

CONTACT LOCAL BUILDING OR FIRE OFFICIALS ABOUT RESTRICTIONS AND INSTALLATION
INSPECTION REQUIREMENTS IN YOUR AREA.

SAVE THESE INSTRUCTIONS FOR FUTURE REFERENCE!



We recommend that our products be installed and serviced by professionals who are certified in the U.S. by NFI (National Fireplace Institute).

www.nficertified.org



A French language version of this manual is available at www.hearthstonetech.com

Intentionally Blank

Notes on Stove Operation and Efficiency

Rating:

You have purchased a Hearthstone Manchester 8330 pellet stove certified to comply to ASTM 1509-02 “Standards for Room Heaters, Pellet Fuel-Burning Type,” ULC/ORD-C1482-M1990 “Requirements for Space Heaters for Use with Particulate Solid Fuels,” and ULC-S627-00 “Standard for Space Heaters for Use With Solid Fuels.” It is certified at 1.3 gr/hr emission rate, is rated as 76.1% efficient, and as such under specific test conditions has been shown to deliver heat at rates ranging from 11,628 to 38,760 Btu (output). U.S. ENVIRONMENTAL PROTECTION AGENCY Certified to comply with 2020 particulate emission standards using pellet fuel.

This pellet heater has a manufacturer-set minimum allowable low burn rate that must not be altered. It is against federal regulations to alter this setting or otherwise operate this wood heater in a manner inconsistent with operating instructions in this manual.

Please refer to the Warranty section of this manual for registration instructions. In case of warranty claims, please contact the point of original sale or the nearest authorized Hearthstone dealer. All warranty claims are processed by our dealer network. Authorized Hearthstone dealers can be located at www.hearthstonestoves.com.

DO NOT BURN: *Garbage, lawn clippings, yard waste, material containing rubber (including tires), materials containing plastic, waste petroleum products paints or paint thinners, asphalt products, materials containing asbestos, construction or demolition debris, railroad ties, pressure treated wood, manure or animal remains, salt water driftwood or other previously salt water saturated materials, unseasoned wood, paper products, cardboard, plywood or particleboard.* Burning these materials may result in a release toxic fumes or render the heater ineffective and cause smoke. This prohibition against burning these materials does not prohibit the use of fire starters made from paper, cardboard, saw dust, wax and similar substances for the purpose of starting a fire in an affected wood heater though it is ***not*** recommended to use a fire starter of any kind in this stove.

This wood heater needs periodic inspection and repair for proper operation. It is against federal regulations to operate this wood heater in a manner inconsistent with operating instructions in this manual. Following the maintenance guidelines set forth in this manual will help insure the efficient use of your wood heater and minimize visible emissions. Having your stove inspected by a trained professional on a regular basis will greatly increase the potential for recognizing potential impacts to efficiency.

Proper draft is important to the efficient operation of your heater. Refer to the Installation Manual for information regarding appropriate flue installation. Follow these guidelines to ensure adequate draft. Both excessive and sub-minimum draft can affect the efficiency of your wood heater. Excessive draft can lead to over-consumption of fuel, lower overall heating capacity of the stove and potential over firing. Low draft can result in inefficient burns, low heat output, expulsion of smoke into the living area when stove doors are opened and an increased potential for build-up of flammable materials in the flue.

Efficiency:

To maximize the efficiency of your pellet stove make sure it is sized properly for the space you plan to heat. An oversized stove will often be forced to burn at a lower and less efficient burn rate. Consult with your dealer for sizing and correctly placing the stove in your home. An incorrectly placed stove can greatly reduce efficiency, such as installations in a basement meant to heat the entire home. Maximizing the efficiency of your stove and installation location will heat your house quickly, burn cleaner and use less fuel.

This stove should be used only with Premium grade pellets as rated by the Pellet Fuel Institute. Lesser grade pellets may produce less efficient burns and result in greater particulate emissions and increased maintenance intervals for your stove. In general, this stove operates in a more efficient manner at higher than minimum run rates; thus, it is better for overall efficiency if this stove runs consistently at or above 50% burn rate. Higher efficiencies and lower emissions generally result when burning softwood pellets. Store unused pellets in a dry space and burn only dry fuel. Using wet pellets will impact starting times, greatly reduce your efficiency and increase maintenance intervals.

CO Emissions:

Hearthstone Heritage and Manchester pellet stoves are considered “deemed certified” stoves as per the 2015 EPA NSPS ruling and were originally tested before CO data was required to be captured in testing.

Smoke/Fire/CO Detectors:

It is highly recommended that smoke and CO detectors be installed throughout the heated space when a wood burning heater is installed. Be certain to install these devices not only in the area where the wood appliance is located, but also in bedrooms, hallways leading to other areas of the house and all common areas of the heated space. Check the batteries in these devices and assure operation by performing whatever test operations are recommended by the manufacturer.

Table of Contents

Introduction.....	5
Important Notes	5
Specifications	6
General Specifications	7
Electrical Specifications	7
Components.....	Error! Bookmark not defined.
Operation.....	10
Loading Pellets	10
Modes of Operation	11
Cycles	14
Lighting a Fire	13
Program Screens/Instructions.....	14
Maintenance.....	31
Ash Disposal.....	31
Daily	32
Weekly or as Needed	32
Monthly	33
Yearly or Every Ton of Pellets	33
As Needed	35
Glass Replacement Procedures	35
Troubleshooting	36
Display Messages:.....	36
General Issues:.....	38
Replacement Parts & Optional Accessories List.....	40
Safety Label	41
Warranty.....	42

Introduction

Congratulations on your purchase of Hearthstone's Manchester pellet fired stove. The Manchester Pellet stove incorporates the latest in pellet burning technology providing you with clean, efficient heat for years to come. Your decision to purchase a Hearthstone Manchester Pellet stove reflects a choice to purchase a premium product and a technology which is carbon neutral, meaning that operation of this stove will not introduce any "new" CO₂ into our atmosphere and minimizes your carbon footprint.

Burning pellets produces essentially the same amount of CO₂ that the same amount of wood decomposing in the forest would produce. Purchase of this product illustrates forward thinking and the thoughtfulness to purchase an environmentally responsible product. Pellet fuel is proven to provide the cleanest burn of any solid fuel, exhausting an average well below the United States EPA wood burning limit. Your Hearthstone Manchester Pellet stove is certified at 1.3g/hr of particulate emissions, well below the current EPA standard, making your stove not only beautiful, but extremely clean burning and efficient as well. This is because the combustion air is closely monitored and modulated by our on-board computer, which optimizes the burn efficiency.

If you have any questions, comments or concerns please contact your local Hearthstone authorized dealer. They are certified industry professionals and should always be consulted on the installation and operation of your Hearthstone appliance for premium performance and trouble free operation and installation.

Hearthstone Quality Home Heating Products offers the best warranty in the industry. Satisfied customers are our top priority.

Important Notes

Please Read this Owner's Manual

Please read this manual in its entirety before installing your stove, thoroughly reading and understanding this manual will help you operate and maintain this pellet heater to ensure years of efficient, economical use. Please operate your stove in accordance with the instructions in this manual. For your safety and trouble free operation, observe a few simple safety precautions and perform some minimal maintenance. The unit will remain appealing while providing years of quality performance.

- 🔥 **WARNING: ENSURE ONLY A HEARTHSTONE DEALER OR AN NFI CERTIFIED PELLET SERVICE TECHNICIAN INSTALLS, AND REPAIRS THIS APPLIANCE. A QUALIFIED SERVICE TECHNICIAN MUST INSPECT THE APPLIANCE BEFORE USE, AND AT LEAST ANNUALLY.**
- 🔥 **WARNING: REGULAR CLEANING IS REQUIRED OR ASH BUILDUP IN THE FIRE BOX COULD IMPEDE OPERATION. IT IS IMPERATIVE THAT THE CONTROL COMPARTMENTS AND CIRCULATING AIR PASSAGES OF THE APPLIANCE ARE KEPT CLEAN AND FREE OF OBSTRUCTIONS. THIS IS NOT A SET AND FORGET APPLIANCE!**
- 🔥 **NEVER BURN PAPER, WOOD OR OTHER MATERIALS**
- 🔥 **CAUTION: DO NOT OPEN THE FRONT DOOR OR ASH PAN UNTIL THE STOVE HAS COOLED COMPLETELY.**

The Manchester Pellet is a pellet fuel burning heater certified and is designed to burn premium natural wood pellets only. Never burn any fuel not intended for use with this unit.

Hot Surfaces

Certain exposed surfaces of the Manchester will reach high temperatures during normal operation. Clearances to combustibles must be maintained, as specified in the "*Clearances to Combustibles*" section of this manual.

- 🔥 **DUE TO HIGH TEMPERATURES, LOCATE THE APPLIANCE OUT OF TRAFFIC LANES AND AWAY FROM FURNITURE, DRAPERIES, CLOTHING AND FLAMMABLE MATERIALS. AS A GENERAL RULE, KEEP ALL COMBUSTIBLES 36 INCHES AWAY.**

Alert children and adults to the hazards of high surface temperatures and the need to stay away to avoid burns to skin or clothing ignition.

Ensure young children are carefully supervised when in the same room as the appliance. Do not place clothing or other flammable material on or near the appliance.

Fire Hazard

- 🔥 In the unlikely event of a soot, or creosote fire – leave the front door and ash drawer closed and shut the unit off (unplug the unit if the chimney fire does not go out immediately). Have the unit and venting inspected before further use.
- 🔥 Do not store or use gasoline or other flammable vapors or liquids in the vicinity of this appliance. Locate stove out of traffic and away from furniture, draperies, clothing, and flammable material.
- 🔥 Never use gasoline, gasoline-type lantern fuel, kerosene, charcoal lighter fluid, or similar liquids to start or ‘freshen up’ a fire in this heater. Keep all such liquids well away from the heater while it is in use.



Specifications

Listed as: Pellet-Fired Direct-Vent Fireplace Heater

Model: Manchester Pellet (8330)

Testing Agency: OMNI-Test Laboratories, Inc.

Tested to:

- ASTM E 1509-04 Standard Specification for Room Heaters, Pellet Fuel-Burning Type
- ULC/ORD-C1482-M1990 Requirements for Space Heaters for Use with Particulate Solid Fuels
- ULC-S627-00 Space Heaters for Use with Solid Fuels

Report No.: 261-S-04b-2 Certified for US and Canada.

Approved for Mobile Home Installation

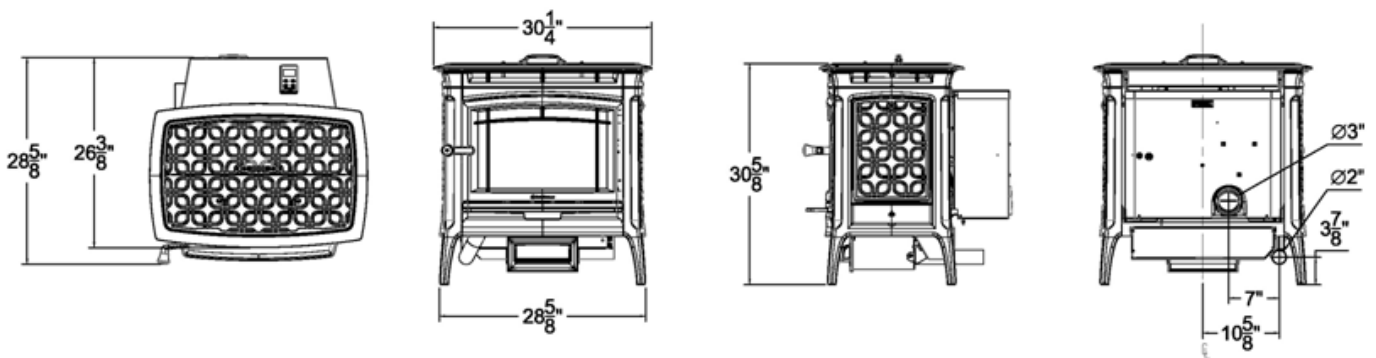

Output Specifications

% max burn	lbs/hr	BTU's*	Hours of burn, 40lb
30	1.8	15,300	22.2
45	2.7	22,950	14.8
70	4.2	35,700	9.5
100	6.0	51,000	6.7

*BTU measurements assume 8,500 btu/lb. Lower quality fuel will reduce heat output and overall performance.

Specifications (cont.)

General Specifications

Stove Weight.....	350 lbs
Pellet Hopper Capacity.....	50 lbs*
Approximate Heating Ability (sq ft).....	up to 2000 sq ft
Burn Rate (lbs/hr).....	1.8 – 6.00 lbs/hr
Fuel.....	PFI certified premium or better Wood Pellets
<i>(Refer to Appendix A for more information about pellet fuel in general)</i>	
EPA Certified Particulate Emissions.....	1.3g/hr
<i>(EPA Standard – 7.5 g/hr)(Data from Omni-Test Laboratories, Inc. Report: 261-S-04-8.3)</i>	

Electrical Specifications

Electrical Rating.....120 V.A.C. 60Hz, 4 Amps

(A grounded surge protector is recommended to protect the circuit board. If the voltage entering your home is below 116 volts your stove may not work properly. Ensure that the polarity of the electrical receptacle that the stove is plugged into is correct.)

Fuse replacement: 3.5 amp minimum to 4 amp maximum rating. Hearthstone PN 7000-185

Watts used (startup) (approx).....	300 Watts
Watts used (max/high burn) (approx).....	160 Watts
Watts used (min/low burn) (approx).....	60 Watts

*All void spaces in hopper filled.

^Dependent on energy efficiency of structure, fuel quality, user operation, and your installation.

Components and Features

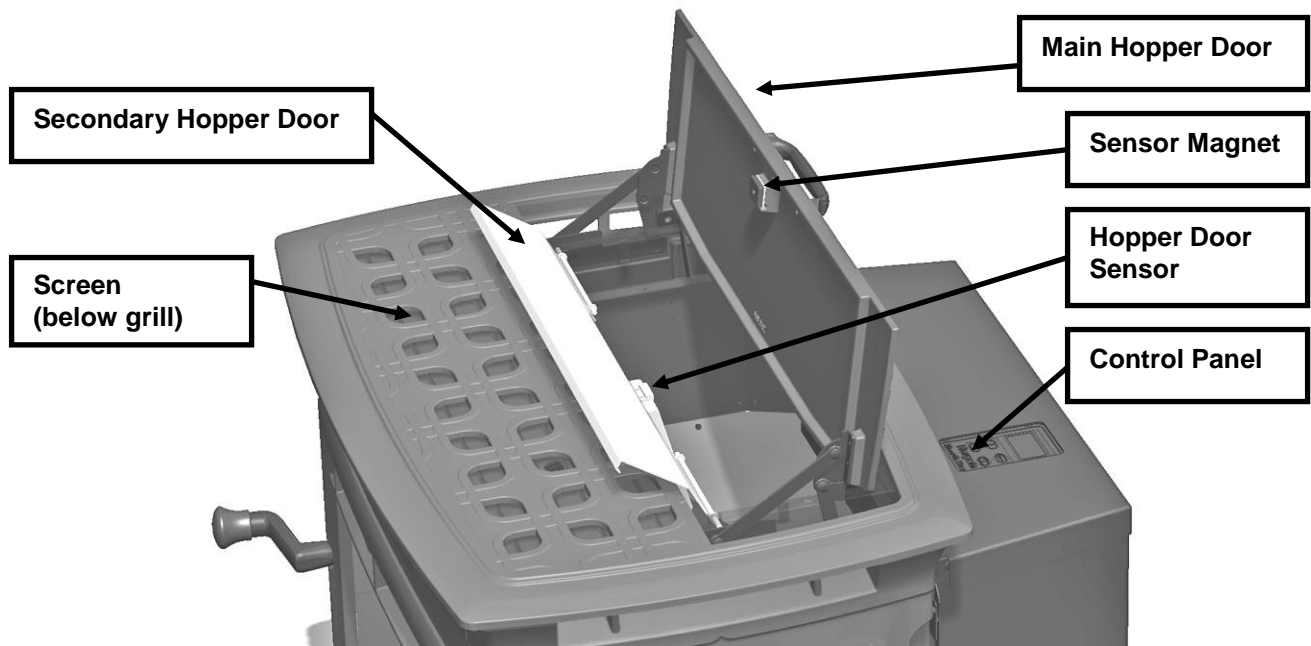
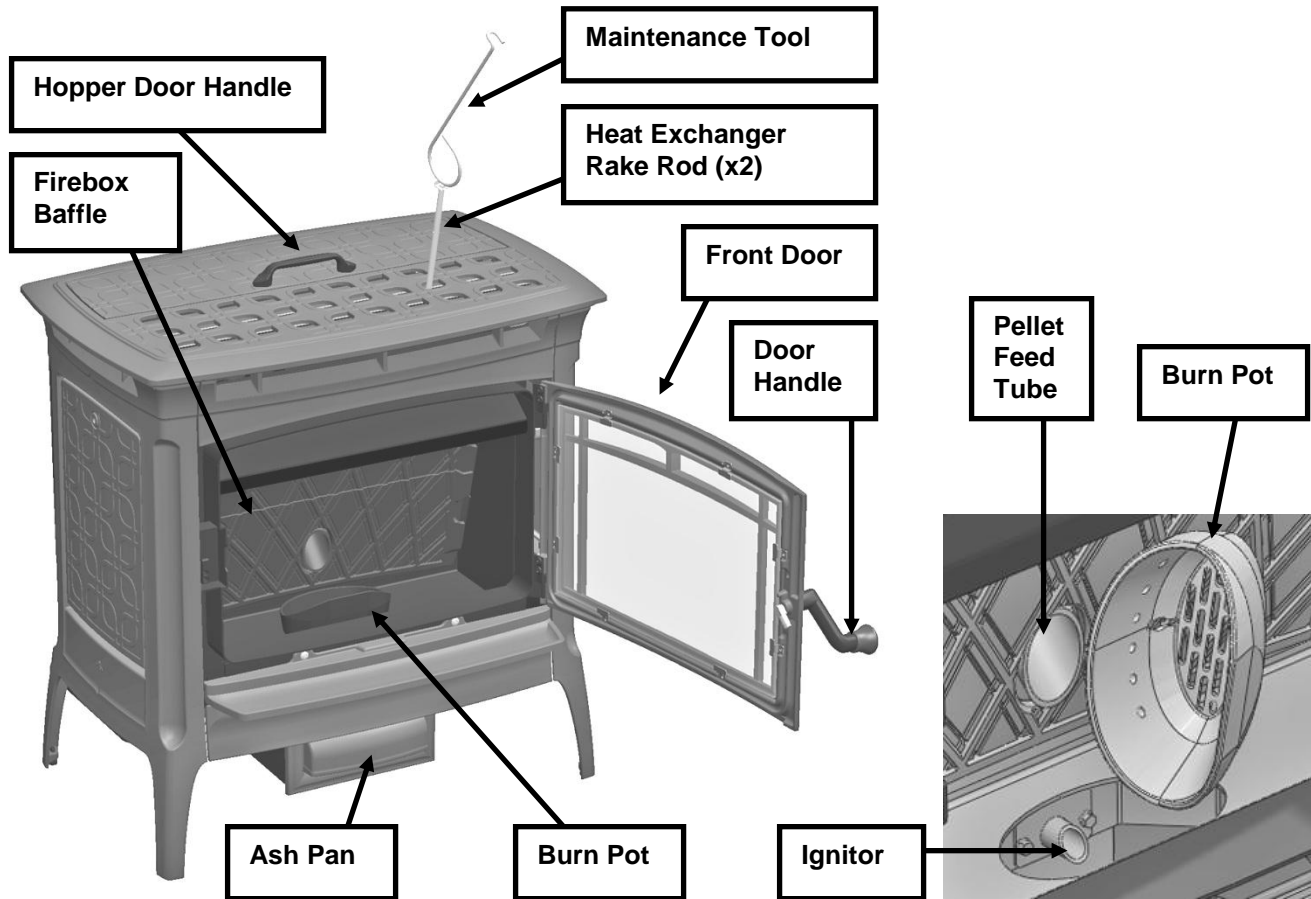

Components and Features (cont.)

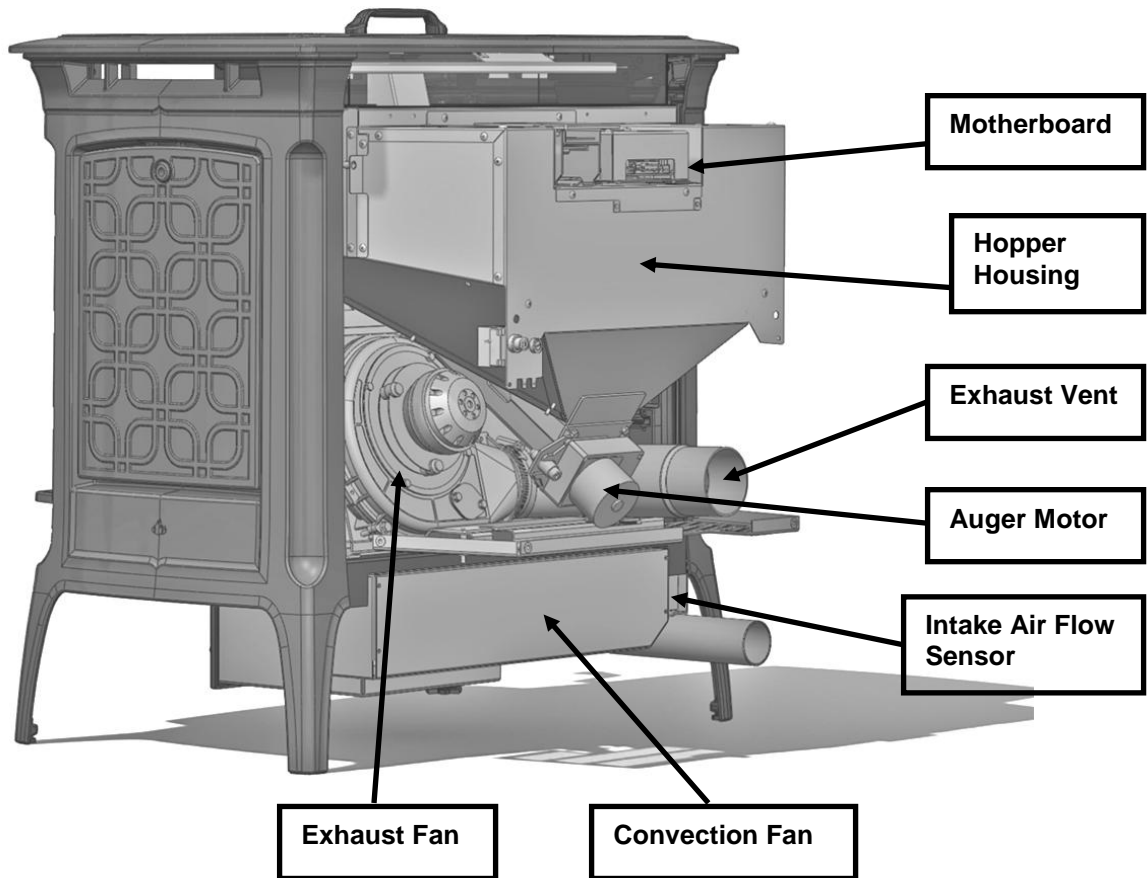
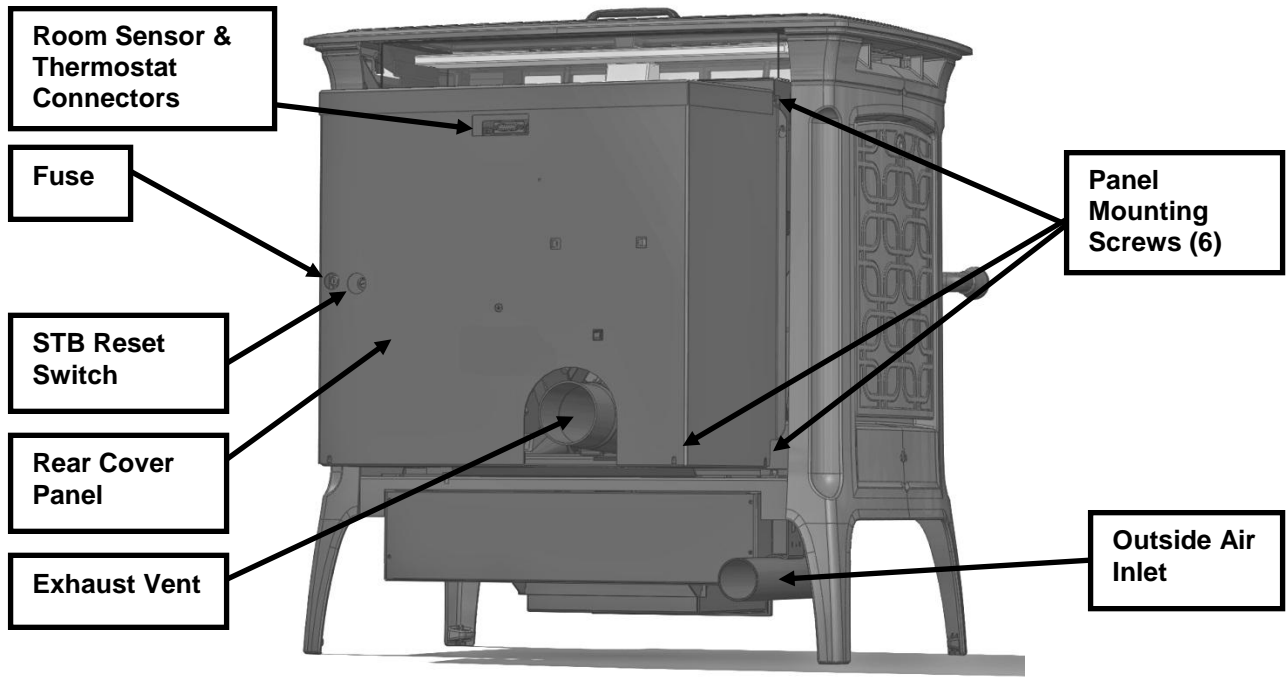

Operation

General Cautions

- 🔥 CAUTION: HOT WHILE IN OPERATION! KEEP CHILDREN, CLOTHING, AND FURNITURE AWAY. CONTACT MAY CAUSE SKIN BURNS.
- 🔥 CAUTION: DO NOT USE CHEMICALS OR FLUIDS TO START THE FIRE.
- 🔥 CAUTION: DO NOT BURN GARBAGE, FLAMMABLE LIQUIDS SUCH AS GASOLINE, NAPHTHA, OR ENGINE OIL.
- 🔥 CAUTION: THIS UNIT IS DESIGNED TO BURN ONLY PREMIUM NATURAL WOOD PELLETS. DO NOT BURN ANY OTHER MATERIAL NOT DESIGNATED AS WOOD PELLET FUEL. USE OF CHUNK WOOD IN THIS STOVE IS PROHIBITED BY LAW. BURNING ANYTHING OTHER THAN WOOD PELLET FUEL CAN CAUSE OVERFIRING, DAMAGE THE APPLIANCE, AND WILL VOID THE WARRANTY.
- 🔥 USE ONLY THE BURN POT DESIGNED FOR THIS STOVE – DO NOT SUBSTITUTE WITH OTHER PARTS OR USE A GRATE TO HOLD THE FUEL.
- 🔥 WARNING: DO NOT ABUSE THE FRONT DOOR GLASS BY STRIKING, OR BY SLAMMING THE DOOR.
- 🔥 CAUTION: DO NOT OPERATE THIS UNIT WITH BROKEN DOOR GLASS.
- 🔥 DO NOT ALLOW FIRE TO BURN TOO CLOSE TO THE GLASS.
- 🔥 DO NOT OPERATE WITH THE FRONT DOOR, OR ASH DRAWER OPEN – THE UNIT WILL SHUT DOWN.
- 🔥 DISCONTINUE OPERATION IF YOU SMELL SMOKE COMING FROM THE HEATER.
- 🔥 IF A MALFUNCTION IS SUSPECTED, TURN THE UNIT OFF USING THE CONTROL PANEL, DO NOT UNPLUG!
- 🔥 IF THE FLAMES BECOME SOOTY, OR THE BURN POT OVERFILLS WITH PELLETS, IT IS RECOMMENDED TO TURN OFF THE STOVE AND THOROUGHLY CLEAN ALL STOVE AREAS AS PER MAINTENANCE DIRECTIONS.
- 🔥 WHEN OPERATING NORMALLY, THIS APPLIANCE COULD TRIGGER SMOKE DETECTORS INSTALLED TOO CLOSE TO THE UNIT.

Loading Pellets

Lift the hopper door vertically until fully opened, open secondary hopper door; add pellets into hopper until full. In order to maximize hopper capacity, push pellets into void spaces. With all voids full, maximum hopper capacity is approximately 50 lbs of pellets. To reduce the introduction of fines, or spillage, we recommend the use of a secondary container to add pellets. Clean up any pellets spilled on, or down inside the stove. Store pellets in a dry location, and outside the required clearances to combustibles of the heater

NOTES:

- 🔥 WARNING! TOP GRILL AND FRONT EDGE OF STOVE CAN BECOME VERY HOT, AVOID ALL CONTACT WITH HEATED SURFACES
- 🔥 IF THE HOPPER DOOR IS LEFT OPEN, A **CAP OPEN** MESSAGE WILL SHOW ON THE DISPLAY. AN OPEN HOPPER DOOR WILL AUTOMATICALLY STOP FUNCTION OF THE FEED AUGER, AS THE AUGER POSES A HAZARD TO FINGERS DURING OPERATION. TO ACKNOWLEDGE THIS MESSAGE, SIMPLY CLOSE THE HOPPER DOOR.

Stove Operation

All operations of the stove are initiated from the User Interface pad. This pad is designed to provide simple, user-friendly operation of the stove. There are only four buttons on the interface pad, **Power (On/Off)**, **MENU**, **+**, **-**. During normal operation, the interface screen will illuminate red. When the unit is in OFF mode, but power is supplied, the pad will display its operational state without the red backlighting. If an error is detected, an error message is displayed, and the readout will flash. See Figure 1 for User Interface Pad reference.

Navigation of the software sub-screens is done using the interface pad. In general, entering a menu is accomplished by pushing one or a simultaneous combination of two buttons, then using another as a means to scroll between sub-screens. When the parameter screen you are interested in affecting is displayed on the LCD readout, pressing one button enters the screen, at which point the plus and minus buttons allow you to change settings. For each menu, the correct procedure and required buttons will be outline later in this manual.

The combustion process in your stove is controlled by a central processor that receives information from multiple sensors installed throughout the stove. Do not attempt to override any of the sensors or your stove may over-fire and damage can result. Further, do not attempt to shorten or override the warm up, cool down or emergency stop burn cycles.

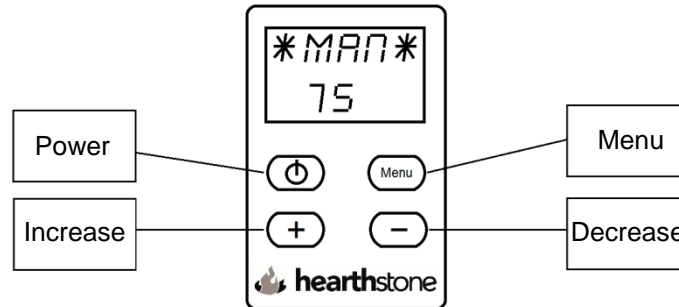

Figure 1 – LCD Screen and Touch Pad

Modes of Operation

Hearthstone pellet stoves have various modes of operation. They are:

- 🔥 **Manual** – Most basic mode (no thermostatic control). This mode is recommended for reasons of predictability in fuel consumption, maintenance schedules, and overall comfort of the living space. In general, pellet stoves work more efficiently in an “always on” operational mode. Selecting Manual mode and choosing a heat output level that maintains a comfortable temperature in the living space without requiring the stove to shut down while the home cools will deliver a more even temperature in the space as well as result in a more efficient burn.
- 🔥 **Thermostat** – Optional mode. Requires an external milli-volt thermostat sold at your local Hearthstone dealer or hardware store and the removal of a jumper wire from the control module. This jumper wire occupies the ports into which the thermostat interface wire is connected (see Installation Manual). Use of this mode can result in shorter periods between required maintenance due to an increased frequency of stove starting and stopping.
- 🔥 **Automatic** – Optional mode. Requires the use of the Hearthstone’s Room Sensor. The Room Sensor modulates the stove to maintain an even room temperature in the living space. This mode works well in large, open floor plan homes where heat from the stove can freely move. In average size spaces, heating in this mode may result in increased starts and stops due to heat loading of the room occurring quickly enough that the stove control is unable to modulate appropriately.
- 🔥 **Programmable** – Optional mode. Requires the use of the Hearthstone’s Room Sensor.

Note: If the stove is triggered to shut down and then triggered to turn back on immediately, it will still go through the complete shut down and startup process.

Operational Cycles

Startup Cycle

All of the operation modes use the same startup cycle. Once the startup sequence is initiated, the stove does not require any user intervention. The entire sequence will take between 10 and 20 minutes depending on the starting temperature of the stove and type of pellets. The igniter, auger, and exhaust fan turn on immediately when the ignition phase is started. The burn pot will partially fill. The amount of filling depends on how full the auger is before the stove is started and the amount of ash and clinkers in the pot. Once the initial amounts of pellets are in the pot, the auger will stop until the pellets ignite. The unit will smoke for a few minutes as the pellets heat, shortly followed by visible flames. Once the flame temperature in the firebox has reached a specific temperature, the unit will progress to the start phase. The start phase operates until the flame temperature sensor in the firebox reaches the normal operating temperature. The convection fan will start as

soon as the ignition sequence is complete and the stove transfers into whatever operational mode the user has selected.

Shutdown Cycle

The display will either read **Stop** or **Off** depending on if the unit is shut down manually or from the wall thermostat / room sensor. When the shutdown process starts, the exhaust fan is switched to high.

Once the fire is fully extinguished the control will either display **OFF** or **STANDBY**.

OFF will display if the shutdown was manually initiated, or **STANDBY**, if it was turned off by either a wall thermostat or a room sensor.

Quick Cleaning Cycle

Every hour the unit enters a quick cleaning cycle. The cleaning cycle is the same for every operating mode. The cleaning cycle will last several minutes, and then the stove will return to the current operating setting. During the cleaning cycle, the feed rate of the pellets decreases and the exhaust fan speed increases.

Shutdown Cleaning Cycle

After the unit runs for five hours, it enters a more extensive shutdown cleaning cycle. The stove cleans the burn pot by stopping the pellet feed and increasing the exhaust fan speed allowing the fire to extinguish completely. Once the fire is out completely, the stove will enter a normal startup cycle.

Standby

When using the Hearthstone Heritage or Manchester pellet stoves in AUTO or TSTAT mode, the stove will shut off if the room sensor or thermostat have met the preset temperature. In these instances, the stove user interface display will read "STBY" and the stove will remain off. Only when the room temperature falls below the preset level will the stove re-ignite and begin operation again.

Power Outages

The stove does not have backup power to operate during power outages. If the unit is installed with no vertical exhaust venting, it may cause smoke to backup into the room. To minimize the potential for smoke entering the room, Hearthstone suggests installing the unit with a minimum of five feet of vertical venting and the use of outside air intake venting. Once the power is restored, the stove will return to the operational setting active prior to the outage. If ignition is required, the stove will enter a special ignition procedure. If you live in an area that experiences frequent power outages, you can use an aftermarket backup power supply for this stove, or you can use a generator. Contact your dealer for purchase options and assistance.

Frost Setting

This stove is equipped with a frost setting. To utilize the setting, the room sensor must be connected and the stove must be turned off in the Automatic or Programmable Modes. If the room temperature drops below 42°F, the stove will automatically turn on at its maximum heat output setting, and then turn off when the room reaches 55°F.

 **Note:** This unit is a supplemental heat source. It will not operate without fuel or electricity. Therefore, unattended operation time is limited. Use extreme caution with this feature.

Below are images of the control and software screens including guides to navigation, selection and setup. Follow the instruction on the applicable pages to select and configure the mode of operation you have selected.

To Turn Stove On or Off

Press the  button to turn the stove on and off.

 **Note:** The stove will not ignite if the set temperature is already achieved.

- 🔥 If the stove is in operation, after pressing the Power button to turn the unit off the display will show “OFF” but the unit may take as long as 15 minutes to fully shut off. This is a safety feature and allows the stove to safely extinguish all burning or smoldering material in the burn pot.

Lighting a Fire

Hearthstone pellet stoves are self priming and require only the push of the Power button to ignite the fuel if the stove is not already in operation. Providing the burn pot is clean and properly installed, stove/ash pan are clean, and the burn chamber is appropriately sealed, the stove should progress through the ignition process automatically. Once the ignition sequence is initiated either by a manual or automatic request, the stove will progress through three distinct stages.

- 1) **IGNIT:** Immediately after the ignition sequence is initiated, the LDC screen will display “IGNIT.” During this phase, the stove will slowly begin filling the burn pot with pellets. This procedure occurs in three timed auger runs, each separated by several minutes. During the pauses, the igniter element and combustion fan are running to ignite the burn pot load.
- 2) **START:** Once flame has been established in the burn pot and the Flame Sensor at the top of the firebox has reached a pre-set temperature, the stove control system will transition to a sustaining fire mode. This mode is identified by “START” on the LCD. The auger begins short, regularly spaced pellet drops into the burn pot and the Flame Sensor is looking for continuous, stable heat. If these conditions are identified, the system will transition into the final run phase.
- 3) **Run:** This final phase is identified by the LCD displaying text relevant to whatever control mode the user has selected. For example: if the user is using the stove in Manual mode and has the overall burn rate set to 50%, the LCD screen will display “MAN 50.” If the user has selected thermostat mode and has set the stove to 75%, the LCD will display “TSTAT 75.” Selecting the room sensor mode, or AUTO, and a room temperature of 75° will result in the display reading “AUTO 75.” This phase is the overall run mode and will continue to be displayed until the stove is either turned off or enters an automatic cleaning phase or standby mode.

Refer to the following graphics for navigation of the software and selecting/configuring operational modes and parameters.

hearthstone Pellet Stoves

Basic Setting : MAN Mode

Operation:

- Operating in the Basic Setting : MAN Mode (Manual mode)
- Turning the stove ON / OFF and adjusting the Heat Output

Conditions • Stove Plugged In

- No Thermostat Connected
- No Room Sensor Connected

1 Plug in the stove:

This indicates that the stove is in MAN Mode. This is the factory setting.

2 Turning on the stove:

This indicates that the stove is igniting. Allow up to 10 min. for the stove to ignite.

PRESS POWER BUTTON

Press and release buttons quickly, unless otherwise noted.

This indicates that the stove is ignited, and climbing toward the Heat Output setting.

3 Adjust the Heat Output:

This shows the percentage of heat output. PRESS + or - to go between 30(%) and 100(%)

PRESS + or - BUTTON MULTIPLE TIMES

4 Turning off the stove:

This indicates that the stove is stopping. Allow 10 minutes for the stove to turn off.

PRESS POWER BUTTON HOLD 3 SECONDS

This indicates that the stove is OFF. The stove may now be restarted.

Advanced Setting : TSTAT Mode



Operation:

- Switching between MAN Mode / TSTAT Mode (Thermostat Mode)
- Operating in TSTAT Mode

Conditions

- Stove Plugged In
- Thermostat Connected (UL apprv Millivolt)
- No Room Sensor Connected

1 Switching between MAN Mode / TSTAT Modeo, Starting the stove in TSTAT Mode:

When the Menu button is released, the screen will change to TSTAT Mode.

PRESS MENU BUTTON HOLD 15 SECONDS

To return to MAN mode, repeat step 1.

This indicates that the stove is in TSTAT Mode. Press the Power Button to start the stove.

PRESS POWER BUTTON

Press and release buttons quickly, unless otherwise noted.

3 Running Cycle in TSTAT Mode:

The stove is igniting, and climbing toward the Heat Output setting.

The stove is stopping.

The stove is in Standing by. Room temp. is satisfied.

Heat Output setting.

4 Turning off the stove:

PRESS POWER BUTTON HOLD 3 SECONDS

This indicates that the stove is OFF.

2 Adjust the Heat Output:

PRESS + or - BUTTON

This shows the percentage of heat output. PRESS + or - to go between 30(%) and 100(%). The thermostat (connected to the back of the stove) will stop and start the stove, always running at the indicated Heat Output.

Allow up to 10 min. for the stove to react to temperature setting changes.

Operation:

- Switching between MAN Mode / AUTO Mode (Automatic Mode)
- Operating in AUTO Mode

Conditions

- Stove Plugged In
- No Thermostat Connected
- Room Sensor Connected

1 Enter the Advanced Setting:

To return to MAN mode, repeat step 1.

The TSTAT OFF screen indicates that you are in the Advanced setting.

2 Enter the MODE menu:

Press and release buttons quickly, unless otherwise noted.

PRESS MENU BUTTON

PRESS MULTIPLE TIMES TO SCROLL

PRESS POWER BUTTON

Press the Menu Button to scroll to the MODE screen.
Press the Power Button while on the MODE screen to enter the Mode menu.

Operation:

- Switching between MAN Mode / AUTO Mode (Automatic Mode)
- Operating in AUTO Mode

Conditions

- Stove Plugged In
- No Thermostat Connected
- Room Sensor Connected

3 Selecting AUTO Mode:

This screen indicates that you are in the MODE menu. Note that the line is blank below the words ISTAT, AUTO, or PROG

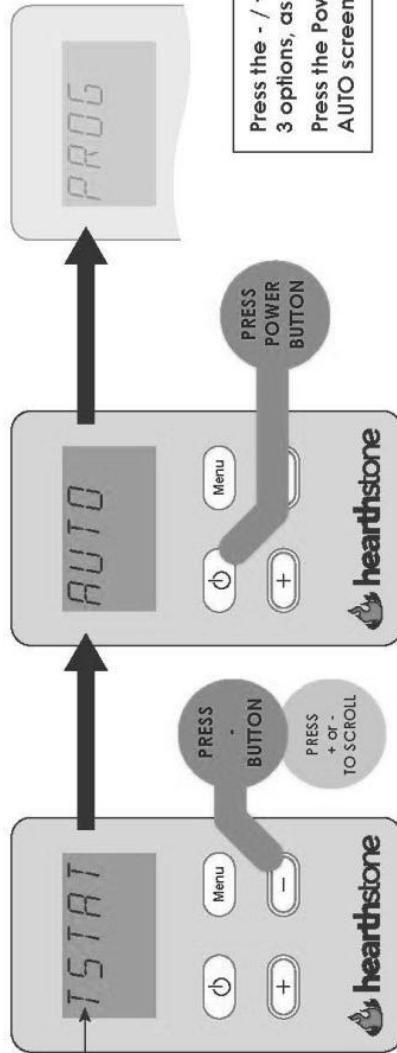

Press the - / + Buttons to scroll through 3 options, as shown.
Press the Power Button while on the AUTO screen to select AUTO Mode.

4 Starting your stove in AUTO Mode:

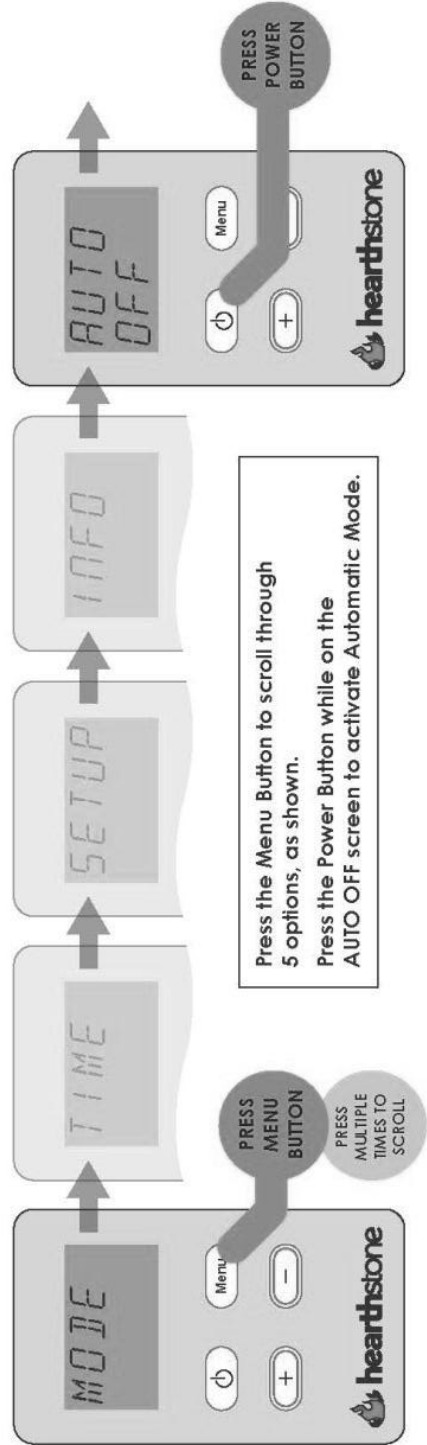

Press the Menu Button to scroll through 5 options, as shown.
Press the Power Button while on the AUTO OFF screen to activate Automatic Mode.

Advanced Setting :AUTO Mode



Operation:

- Switching between MAN Mode / AUTO Mode (Automatic Mode)
- Operating in AUTO Mode

Conditions

- Stove Plugged In
- No Thermostat Connected
- Room Sensor Connected

5 Adjusting the Heat Output:

6 Turning off the stove:

7 Running Cycle in Automatic Mode:

Operation:

- Switching between MAN Mode / PROG Mode (Programmable Mode)
- Operating in PROG Mode

Conditions

- Stove Plugged In
- No Thermostat Connected
- Room Sensor Connected

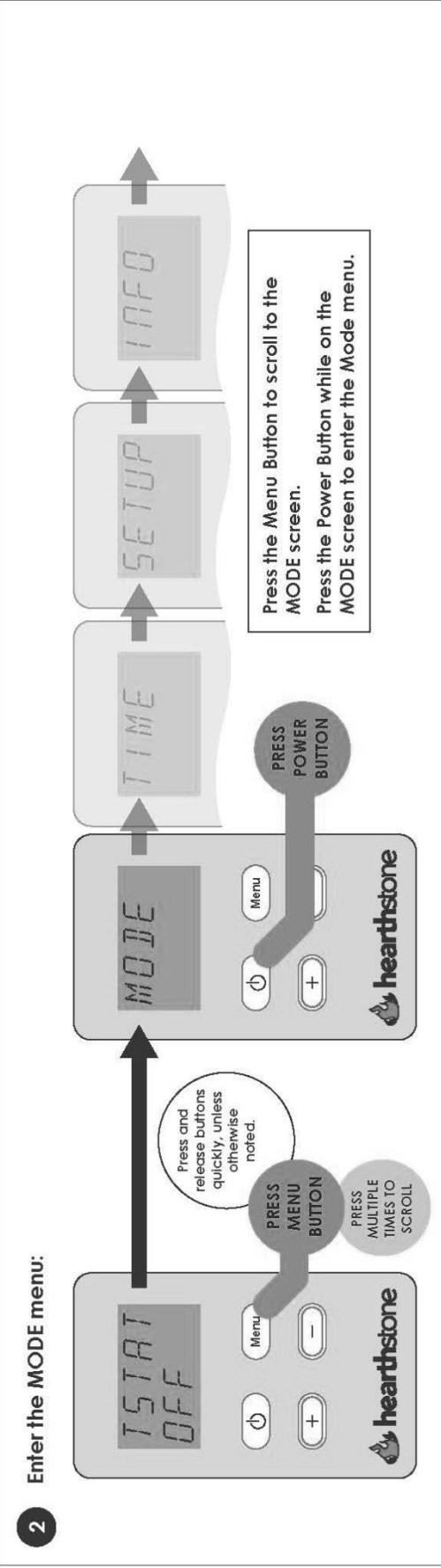
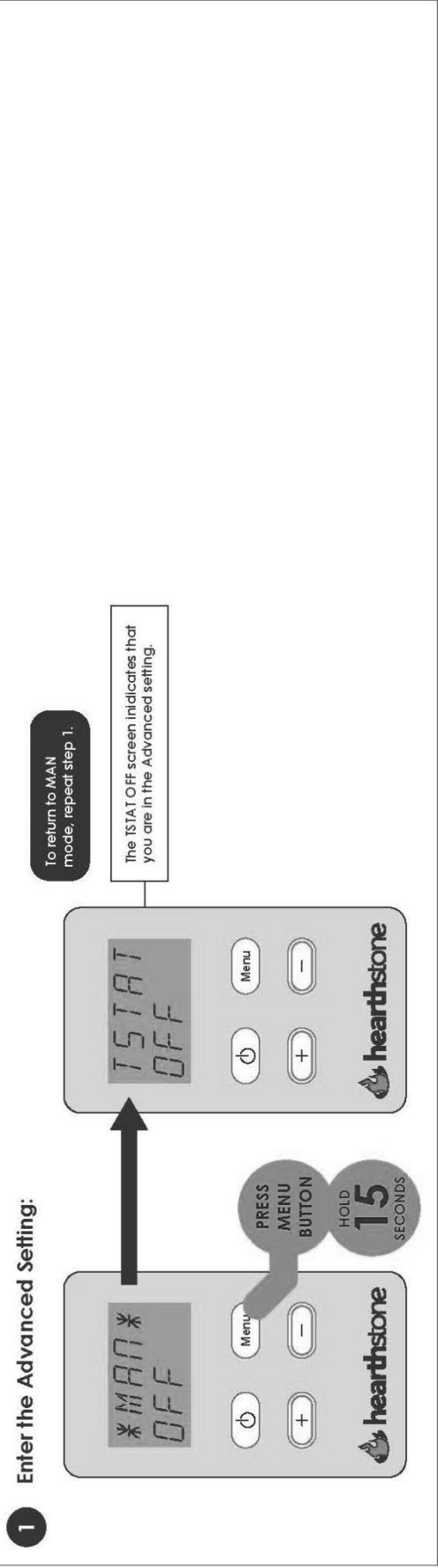

Operation:

- Switching between MAN Mode / PROG Mode (Programmable Mode)
- Operating in PROG Mode

Conditions

- Stove Plugged In
- No Thermostat Connected
- Room Sensor Connected

3 Selecting PROG Mode:

This screen indicates that you are in the MODE menu. Note that the line is blank below the words TSTAT, AUTO, or PROG

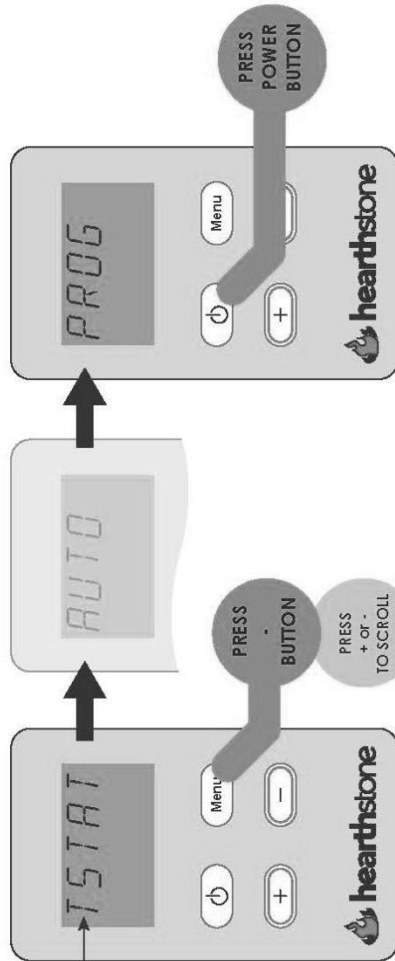

Press the - / + Buttons to scroll through 3 options, as shown. Press the Power Button while on the PROG screen to select PROG Mode.

4 Enter the Time menu:

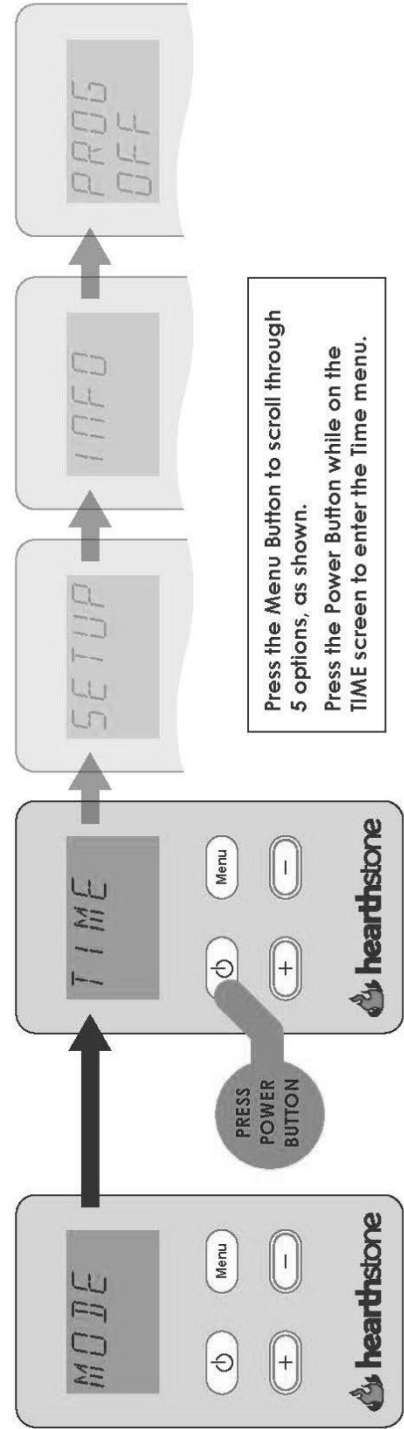

Press the Menu Button to scroll through 5 options, as shown. Press the Power Button while on the TIME screen to enter the Time menu.

Operation:

- Switching between MAN Mode / PROG Mode (Programmable Mode)
- Operating in PROG Mode

Conditions

- Stove Plugged In
- No Thermostat Connected
- Room Sensor Connected

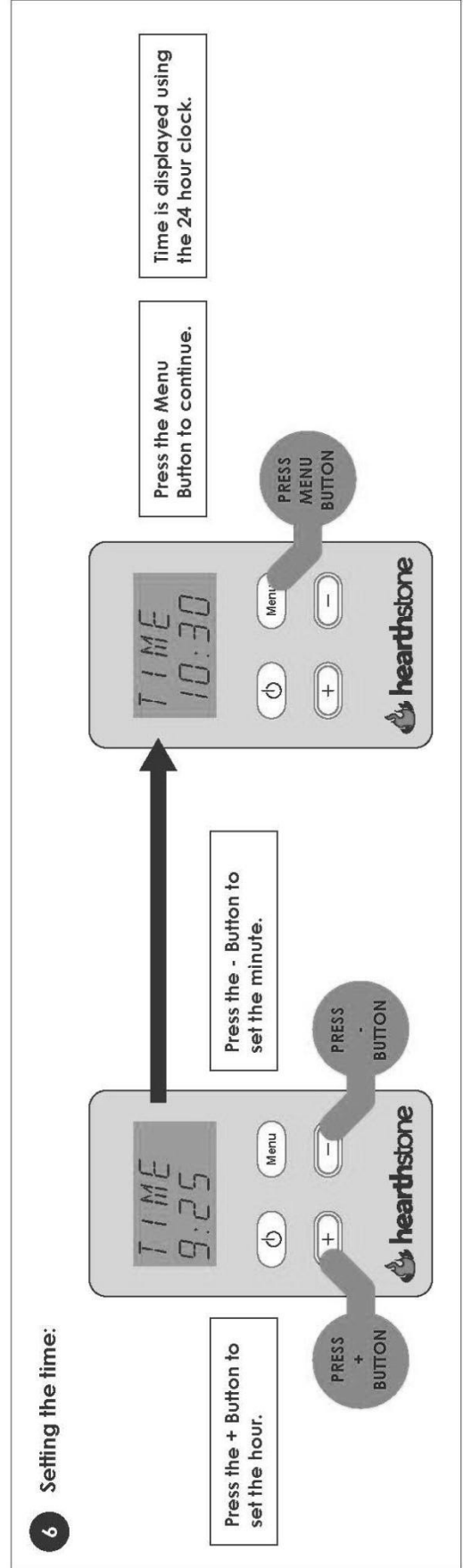
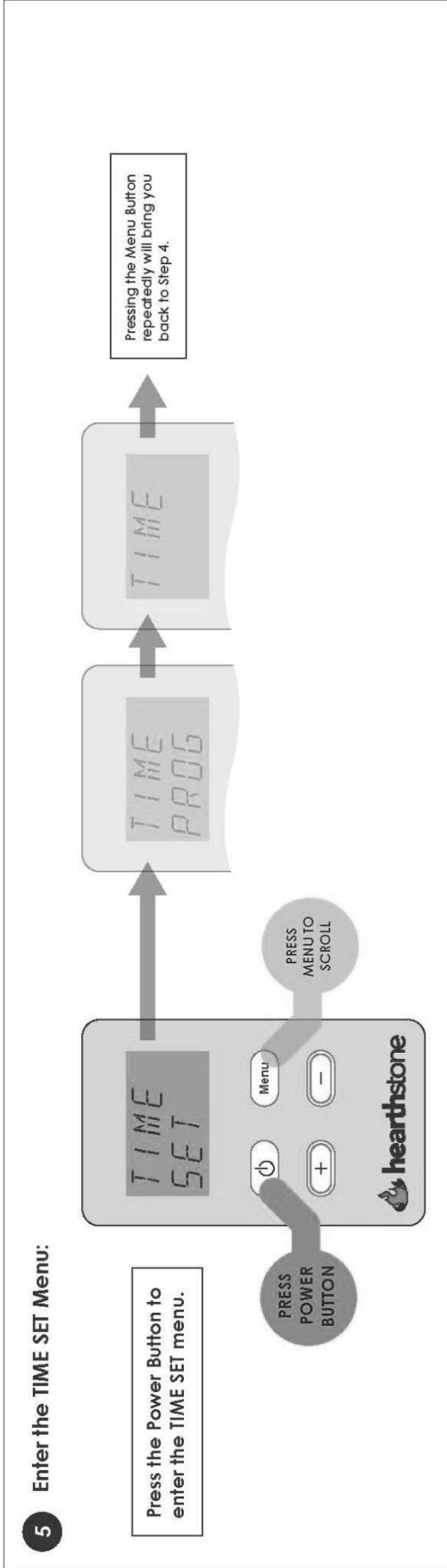

hearthstone Pellet Stoves

Advanced Setting :PROG Mode

Operation:

- Switching between MAN Mode / PROG Mode (Programmable Mode)
- Operating in PROG Mode

Conditions

- Stove Plugged In
- No Thermostat Connected
- Room Sensor Connected

7 Setting the day:

Press the + or - Button to select the current day of the month.

Press the Menu Button to continue.

PRESS + or - BUTTON

PRESS MENU BUTTON

8 Setting the month:

Press the + or - Button to select the current month.

Press the Menu Button to continue.

PRESS + or - BUTTON

PRESS MENU BUTTON

9 Setting the year:

Press the + or - Button to select the current year.

Press the Menu Button to continue.

PRESS + or - BUTTON

PRESS MENU BUTTON

10 Confirm the Time / Date settings:

Pressing the Menu Button to confirm that the day is correct.

This indicates the current day of the week.

MO (Monday)
TU (Tuesday)
WE (Wednesday)
TH (Thursday)
FR (Friday)
SA (Saturday)
SU (Sunday)

PRESS + or - BUTTON

PRESS MENU BUTTON

Operation:

- Switching between MAN Mode / PROG Mode (Programmable Mode)
- Operating in PROG Mode

Conditions

- Stove Plugged In
- No Thermostat Connected
- Room Sensor Connected

11 Programming Options:

Programming your stove allows you to set 2 different Heat Output levels: one for when you are Home, and one for when you are Away.

Your stove must be set with 2 Home time periods. This would typically mean one Home time period in the morning, and one Home time period in the evening. The Away time periods fall in between the Home time periods.

You must choose one of two options when programming your stove: WEEK or DAY

WEEK - Set one program for the week, every day will run on the same schedule.

DAY - Set a specific program for each day of the week.

12 Enter the TIME PROG Menu:

Press the Power Button to enter the TIME PROG menu.

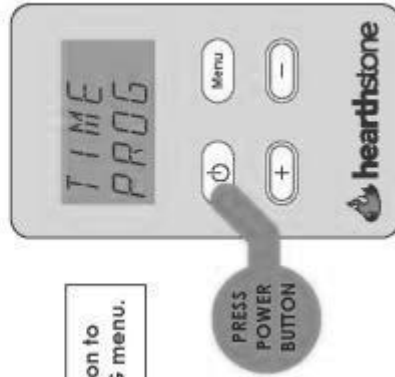

13 Setting one program for the week:

Press the Power Button while on the WEEK screen to set one program for all days of the week.



Skip to step 8 if setting one program for the week

14 Setting a program for each day of the week:

Press the + Button to scroll to the DAY screen. Press the Power Button to Program the individual days.

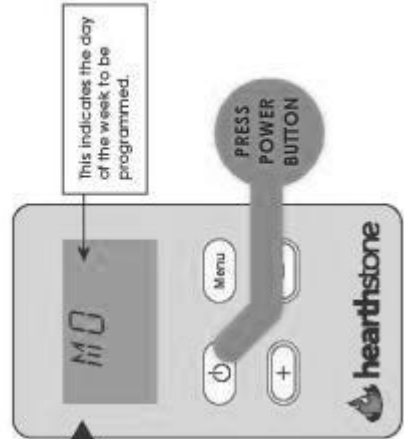
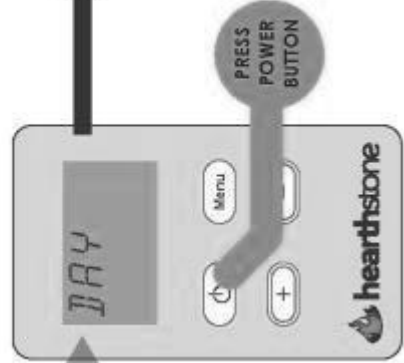

Operation:

- Switching between MAN Mode / PROG Mode (Programmable Mode)
- Operating in PROG Mode

Conditions

- Stove Plugged In
- No Thermostat Connected
- Room Sensor Connected

15 Setting the first Home time period:

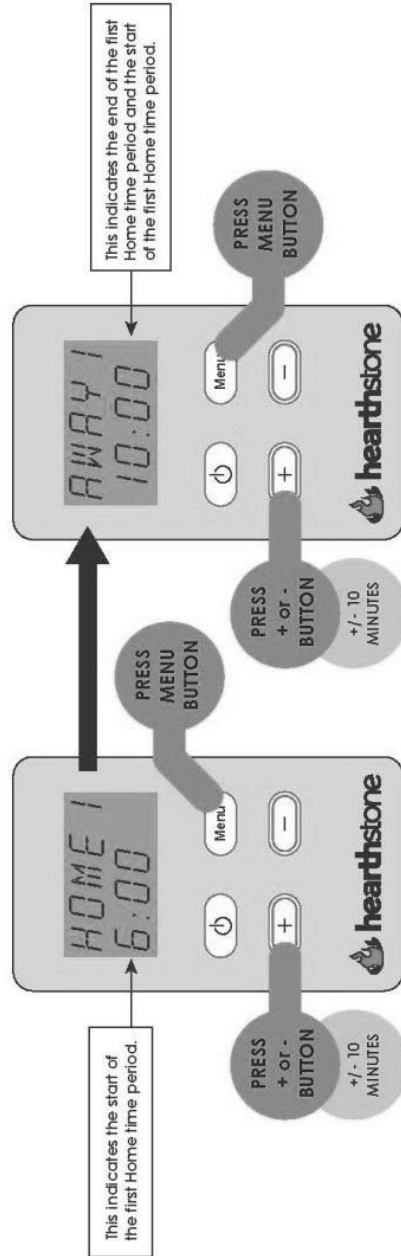

Time is displayed using the 24 hour clock.

This sets the beginning time and end time between which you are usually at home in the morning. In this case, between 6:00am and 10:00am the stove will run at the Home temperature. Before and after this time period, the stove will run at the Away temperature. Both the Home and Away temperatures will be defined after programming.

16 Setting the second Home time period:

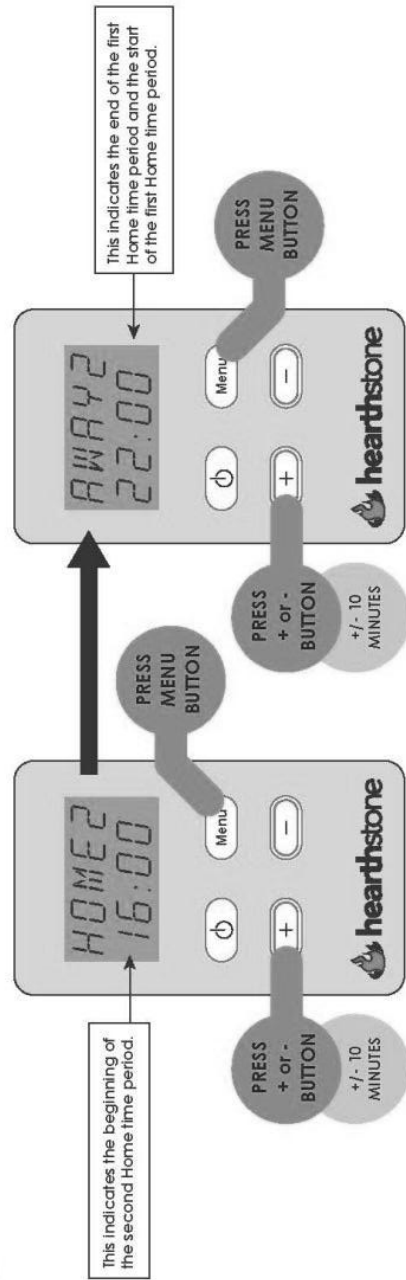

Time is displayed using the 24 hour clock.

This sets the beginning time and end time between which you are usually at home in the evening. In this case, between 4:00pm and 10:00pm the stove will run at the Home temperature. Before and after this time period, the stove will run at the Away temperature. Both the Home and Away temperatures will be defined after programming.

Operation:

- Switching between MAN Mode / PROG Mode (Programmable Mode)
- Operating in PROG Mode

Conditions

- Stove Plugged In
- No Thermostat Connected
- Room Sensor Connected

17 Starting the stove with one program for the week: (Only applies if you followed step 13)

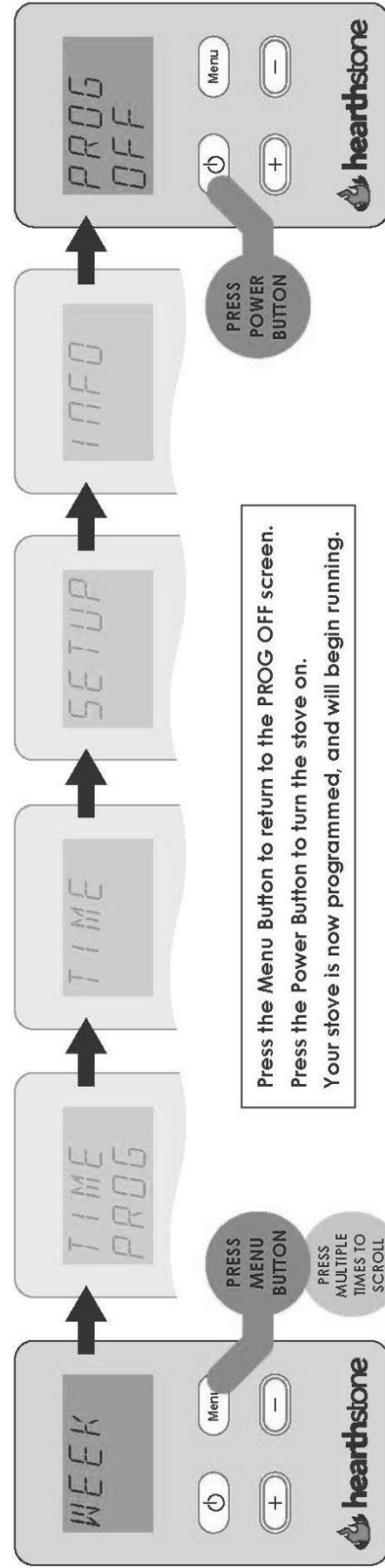

18 Programming each day of the week: (Only applies if you followed step 14)

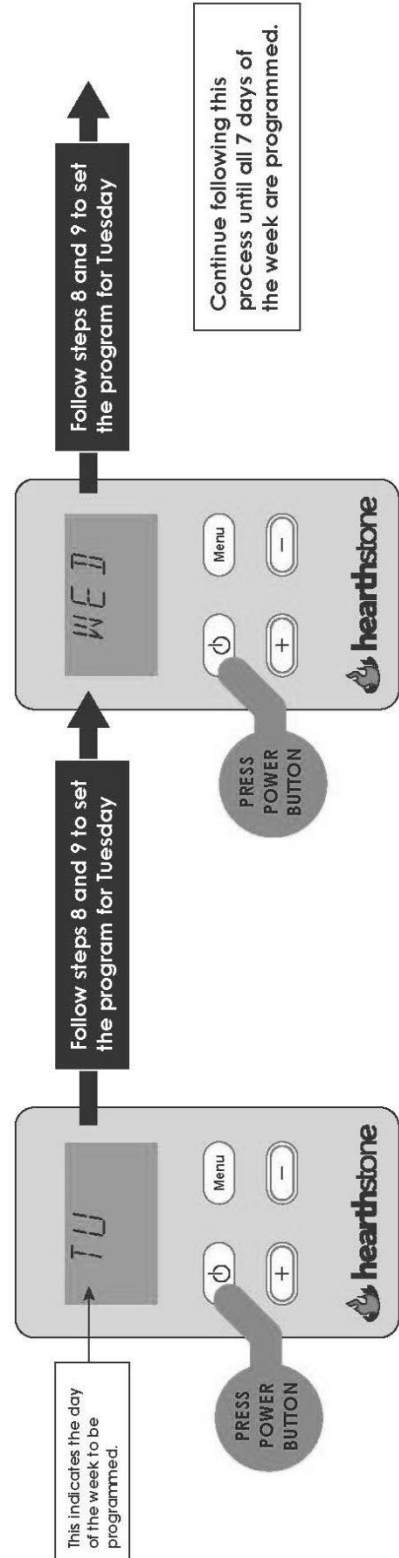

Operation:

- Switching between MAN Mode / PROG Mode (Programmable Mode)
- Operating in PROG Mode

Conditions

- Stove Plugged In
- No Thermostat Connected
- Room Sensor Connected

19 Starting the stove with each day of the week programmed: (Only applies if you followed step 18)

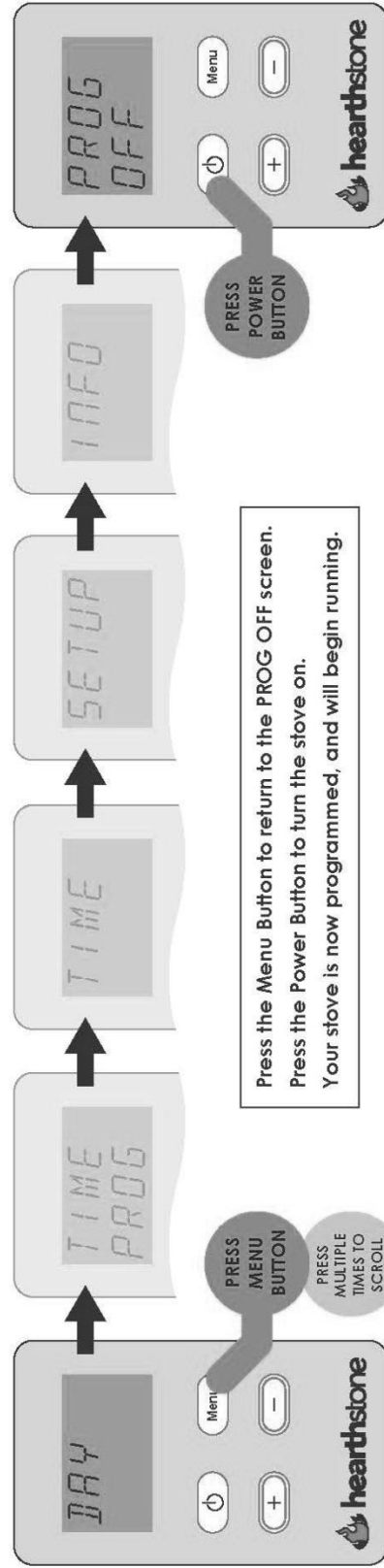

20 Setting the Home temperature:

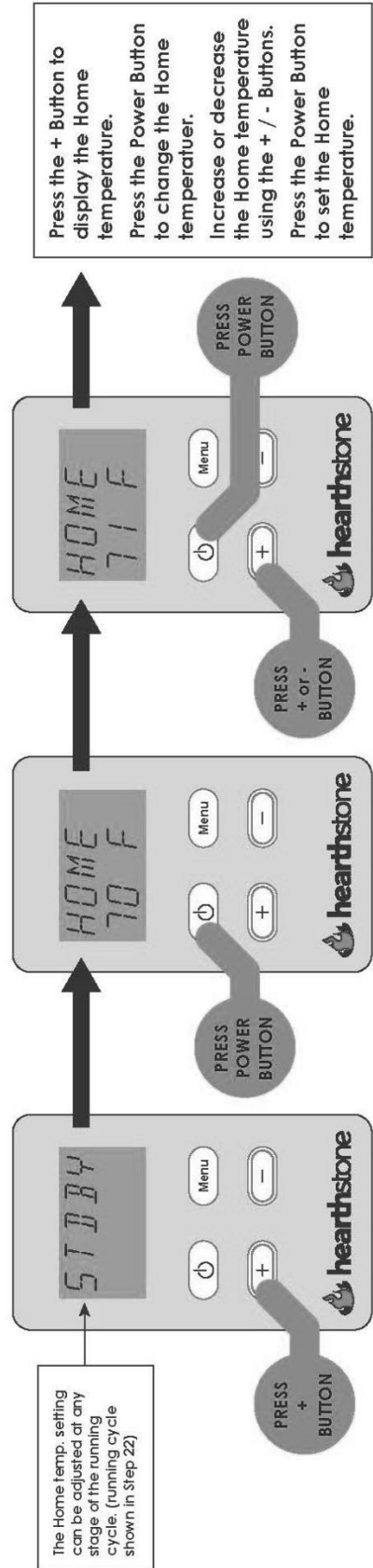

Operation:

- Switching between MAN Mode / PROG Mode (Programmable Mode)
- Operating in PROG Mode

Conditions

- Stove Plugged In
- No Thermostat Connected
- Room Sensor Connected

21 Setting the Away temperature:

The Away temp. setting can be adjusted at any stage of the running cycle. (running cycle shown in Step 22)

Press the - Button to display the Away temperature.
Press the Power Button to change the Away temperature.
Increase or decrease the Away temperature using the + / - Buttons.
Press the Power Button to set the Away temperature.

PRESS + BUTTON

PRESS POWER BUTTON

PRESS + or - BUTTON

PRESS POWER BUTTON

22 Running Cycle in Programmable Mode:

The stove is igniting.

The stove is ignited, and climbing toward the Heat Output setting.

The stove is stopping.

The stove is in Standing by. Room temp. is satisfied.

















23 Turning off the stove:

PRESS POWER BUTTON HOLD 3 SECONDS

This indicates that the stove is OFF.

Programming

Set the Current Time/Date (Programmable Mode)

Prog 70 F	Action
time	Step 1: From the main display press  twice.
Time Set	Step 2: Press the  button to enter the Time menu.
Time 9:25	Step 3: Press the  button to enter the Time Set area.
day 25	Step 4: Use the  button to set the hour and the  button to set the minutes. Once the time is set press  to continue. <i>Note: 24 hour clock is used on this stove.</i>
Month 12	Step 5: Use the  and  buttons to change and set the current day of the month. Press  to continue.
Year 2009	Step 6: Use the  and  buttons to change and set the current month of the year. Press  to continue.
we - 1:0 -	Step 7: Use the  and  buttons to change and set the current year. Press  to continue.
Prog 70 F	Step 8: The current day of the week displays. Press  to confirm the date settings.

Programming the Heating Schedule (Programmable Mode)





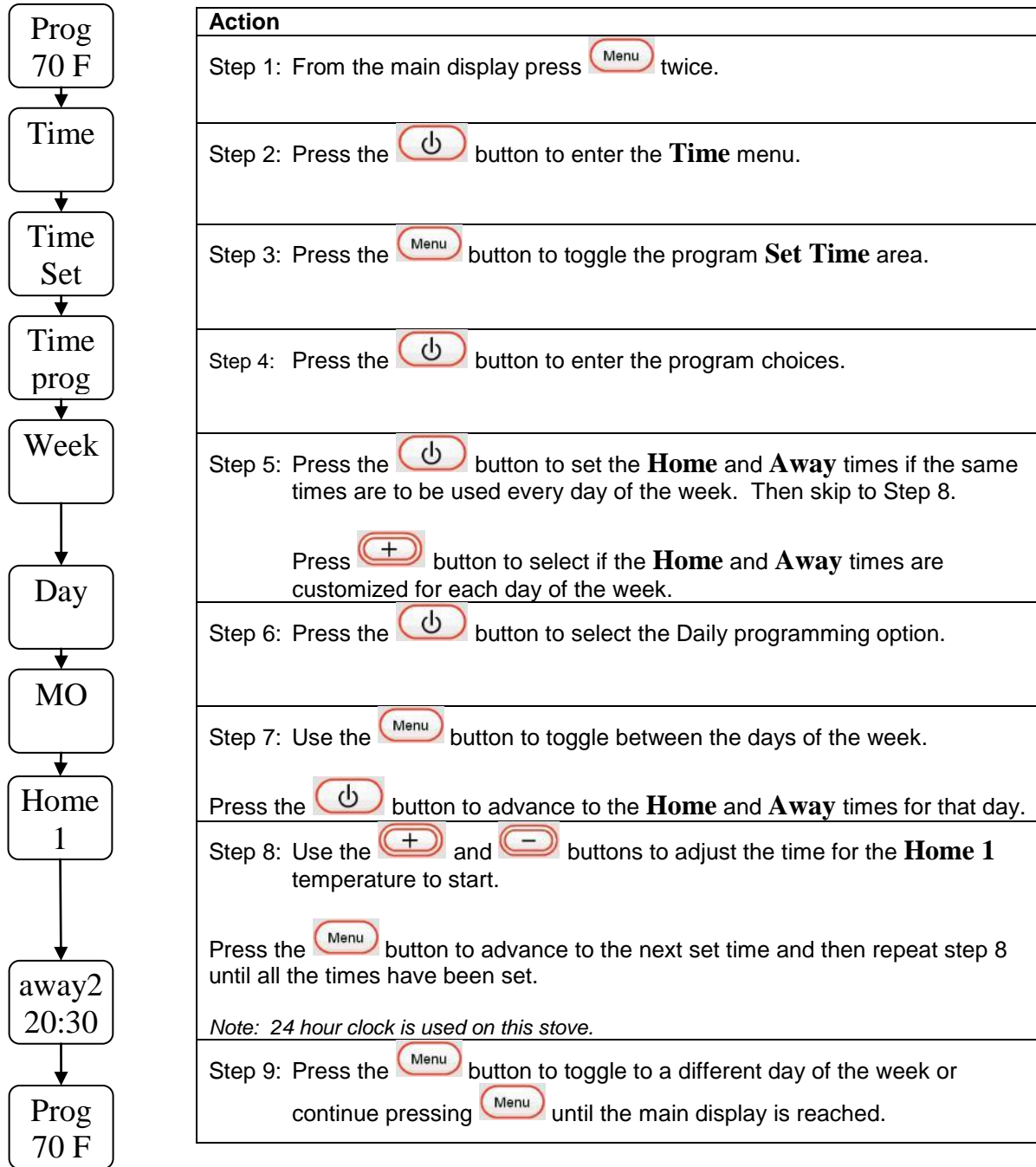

The stove can be programmed with two different set temperatures, one home and one away. Each of these set temperatures have two different times they can be switched on. The stove can use the same Home and Away time every day of the week or they can be set differently for every day.

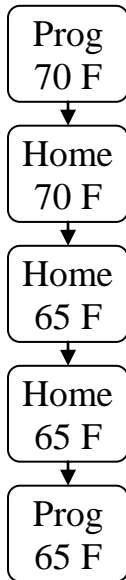
Setting the Home and Away schedule









To Adjust Home and Away Temperature (Programmable Mode)

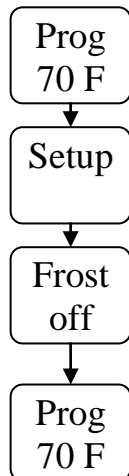

Action
Step 1: From the main display press  to view the Home set temperature or  to view the Away set temperature.
Step 2: Press the  to modify the set temperature.
Step 3: Use the  and  buttons to change the temperatures.
Step 4: Press the  button to confirm the change in the set temperature.

Turning On and Off the Frost Setting









Action
Step 1: From the main display press  three times.
Step 2: Press the  button to enter the setup menu.
Step 3: Press the  button turn the frost setting on and  to turn the frost setting off.
Step 4: Continue pressing  until the main display is reached.





Adjusting the Exhaust Fan Speed

You should only adjust the exhaust fan speed if the flames have an orange, dirty look and the burn pot has to be cleaned more than once a day. If the fan speed is too high, the fire will extinguish when on the lowest burn rate, and the **No Pellets** error will appear on the display.

Changing the Exhaust Fan Speed



Action
Step 1: From the main display press  three times.
Step 2: Press the  button to enter the setup menu.
Step 3: Press  twice.
Step 4: Press the  and  buttons to adjust the fan speed faster and slower. The maximum setting is +30 and the minimum is -10.
Step 5: Continue pressing  until the main display is reached.

Maintenance

-  **ALWAYS WORK ON A COOL STOVE!**
-  **ALWAYS DISCONNECT THE POWER BEFORE PERFORMING ANY MAINTENANCE.**
-  **WARNING: DO NOT USE ABRASIVE CLEANERS ON THE DOOR GLASS. SCRATCHING THE CERAMIC GLASS WILL COMPROMISE ITS STRENGTH.**
-  **WARNING: DO NOT CLEAN THE GLASS WHILE THE STOVE IS BURNING, OR WHEN THE GLASS IS HOT.**

Proper maintenance is essential to clean and reliable performance of your Hearthstone Stove. Operating the stove while in need of service can increase visible emissions, effect overall heat output, interfere with starting and cause sooting of the door glass.

Your Heritage Pellet stove requires routine maintenance and care. Ensure your stove is cool to the touch and unplugged during cleaning or service. Have qualified service personnel inspect the unit and venting once a year to ensure that they are clean, free of obstruction, safe, and in good working order. If service is required, only qualified service personnel should perform it.

-  **WARNING: DO NOT SUBSTITUTE MATERIALS. FOR REPLACEMENT PARTS, OR FOR INFORMATION ABOUT PARTS OR SERVICE, CONTACT YOUR LOCAL HEARTHSTONE DEALER.**
-  **NOTE: TURN THE UNIT OFF. ALLOW THE UNIT TO COOL. DO NOT OPEN THE ASH PAN OR FRONT DOOR UNTIL THE STOVE IS COMPLETELY COOLED.**
-  **Do not just drop the side doors – let them down gently! Dropping the doors will chip the enamel.**

Ash Disposal

Disposal of Ashes – Ashes should be placed in a steel container with a tight fitting lid. Other waste shall not be placed in this container. The closed container of ashes should be placed on a noncombustible floor or on the ground, well away from all combustible materials, pending final disposal. If the ashes are disposed of by burial in soil or otherwise locally dispersed, they should be retained in the closed container until all cinders have been thoroughly cooled. Ensure you firmly seat the ash pan when ash removal is completed.

-  **Note: Do not open the ash pan or front door until the stove is completely cooled.**

Daily

Clean burn pot

1. Open front door.
2. Check for buildup, and remove clinkers if present.
3. Remove burn pot and sweep ashes into ash pan if necessary.
4. Clean and check burn pot for wear.

Burn Pot

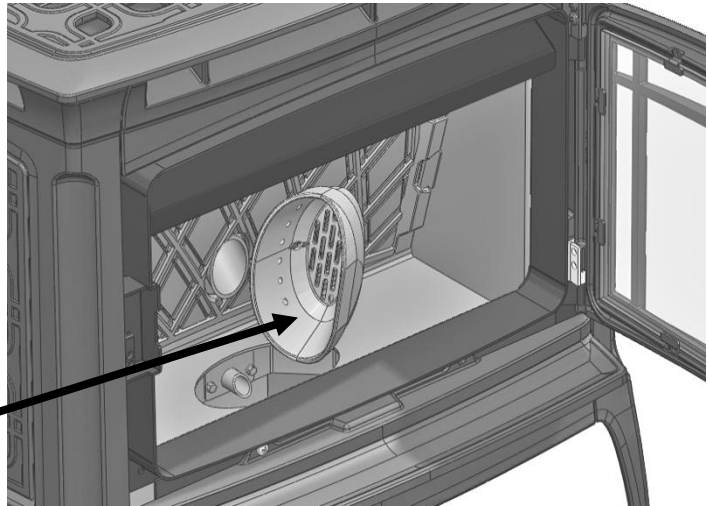

Clean heat exchanger

1. Exercise both rakes using provided maintenance tool.

Maintenance Tool

Rake Rod

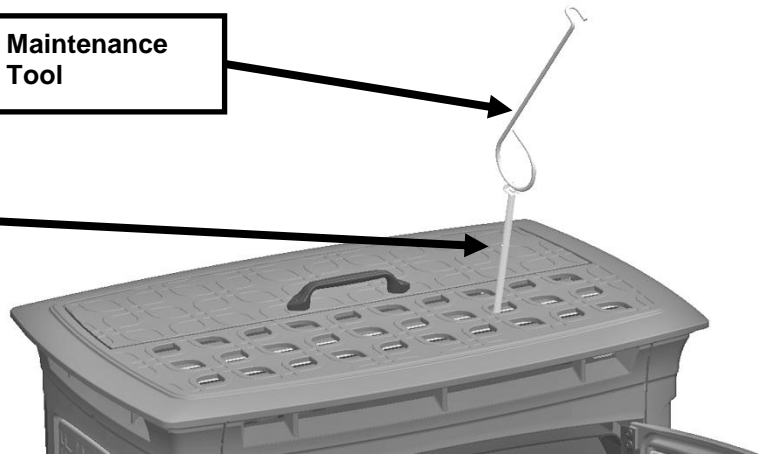

Weekly or as Needed

Remove ash from firebox

1. Lift burn pot, sweep ashes into ash pan or use an ash vacuum.

⚠ **WARNING! USE OF A REGULAR VACUUM MAY CAUSE A FIRE.**

Remove ash from ash pan

1. Remove drawer, deposit ashes in proper metal receptacle with closable lid.

Clean glass

⚠ **DO NOT USE ABRASIVE CLEANERS ON THE GLASS.**

1. Use glass cleaner and soft cloth, or use pellet ash and a water moistened cloth (rub lightly).

Ash Pan

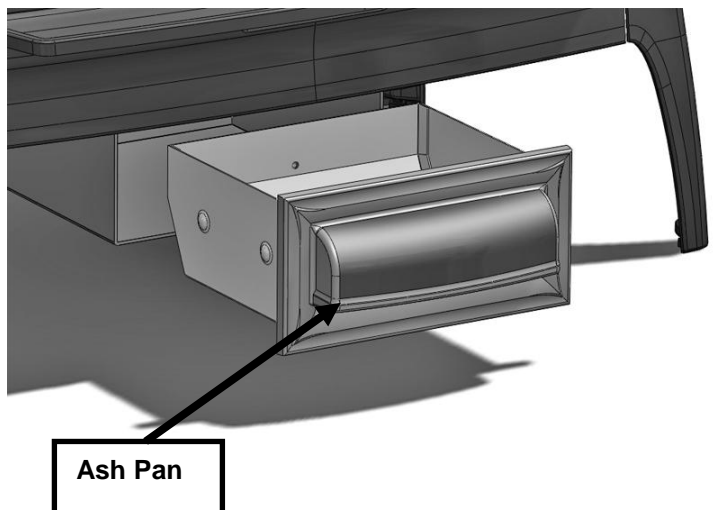

Monthly

Clean Hopper & Auger

1. Remove auger access plate inside hopper (8mm wrench or socket).
- 🔥 **AVOID DROPPING BOLTS INTO AUGER.**
2. Vacuum any fines in hopper and auger trough.
3. Replace access plate.

Auger Access Plate

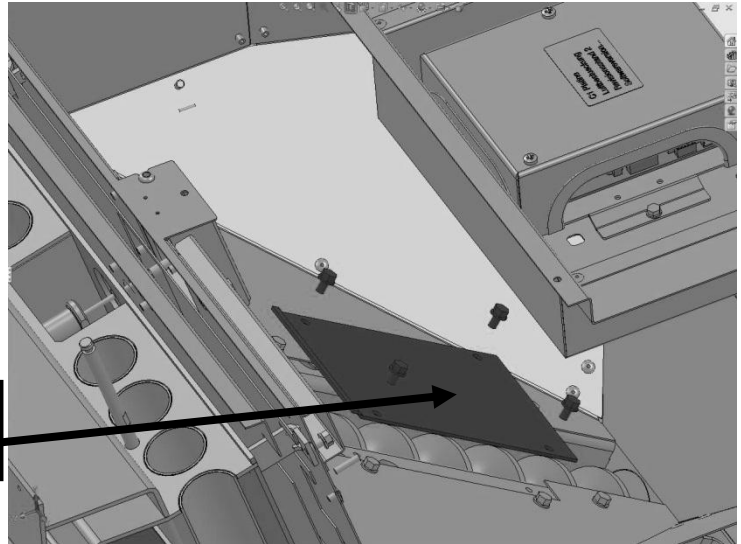

Yearly or Every Ton of Pellets

Clean Hopper, Auger & Exterior of Pellet Engine

1. Remove hopper door – vacuum hopper and auger inlet.
2. Remove top casting and grille assembly – vacuum all surfaces.
3. Open both side doors (using hex wrench) – **let side doors down gently!** Remove rear panel – vacuum all surfaces

Remove the screws to remove the hopper door.

Do not remove secondary door.

Top Casting

Rear Panel

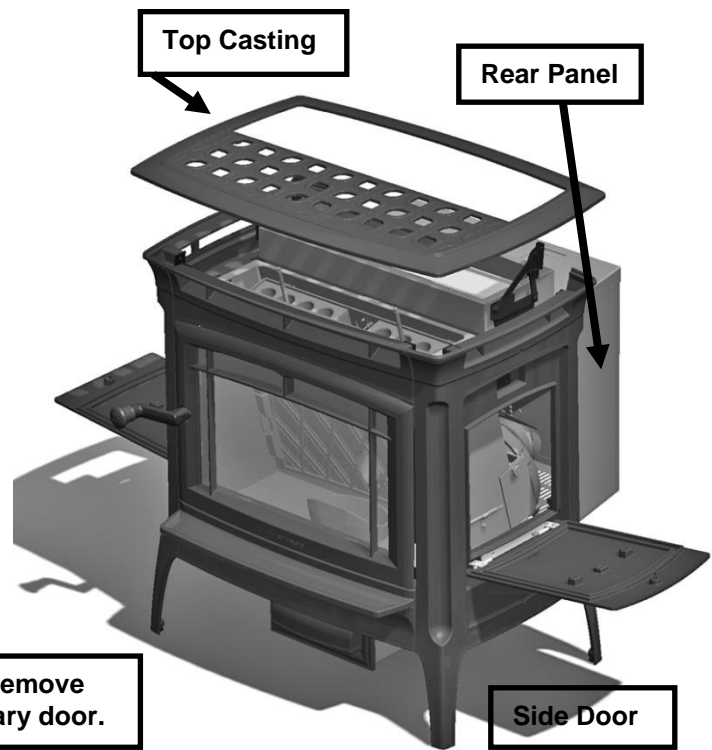
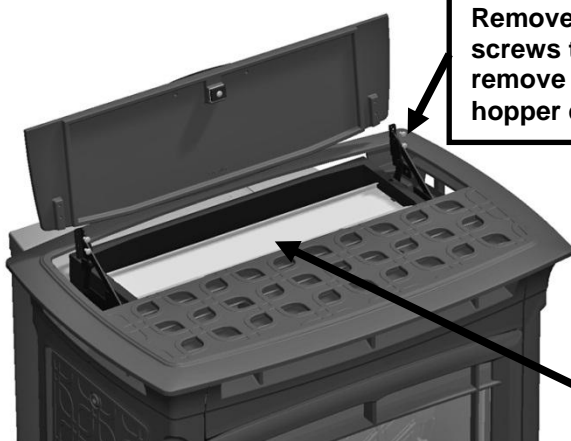

Side Door

Clean Baffles & Heat Exchanger

1. Remove and clean firebox baffles. Inspect for burn through or cracking – replace as required.
2. Exercise rakes, vacuum all accessible surfaces and spaces
3. Clean convection fan impeller cage with a soft brush – vacuum as necessary.

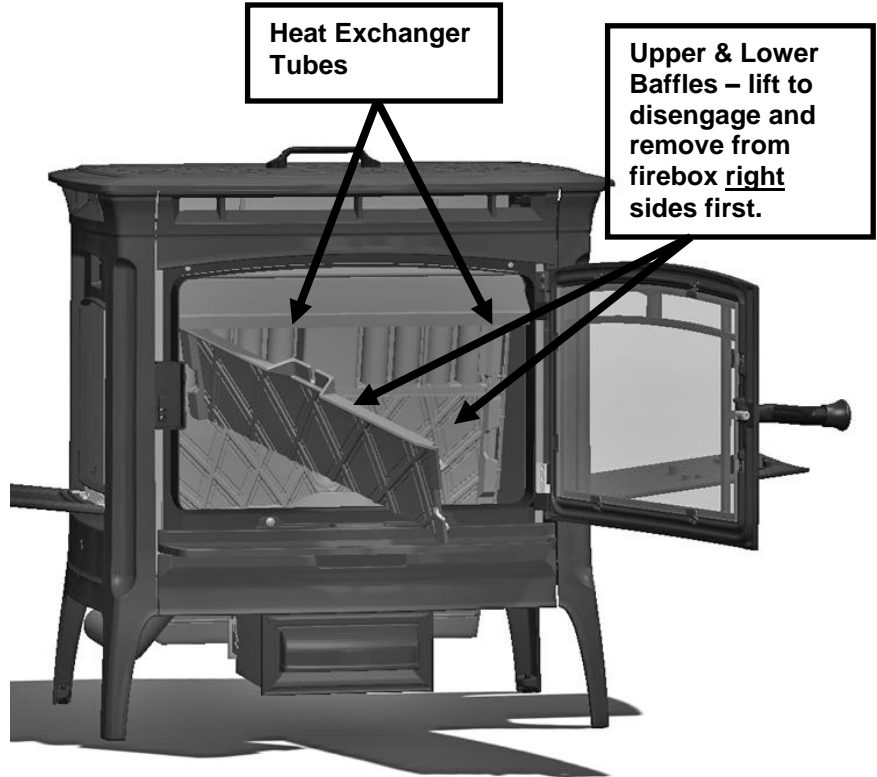

Clean Convection Fan

1. Remove the screen panel (4 screws) – vacuum screen and inside housing, remove any build up from fan blades with soft bristle brush.

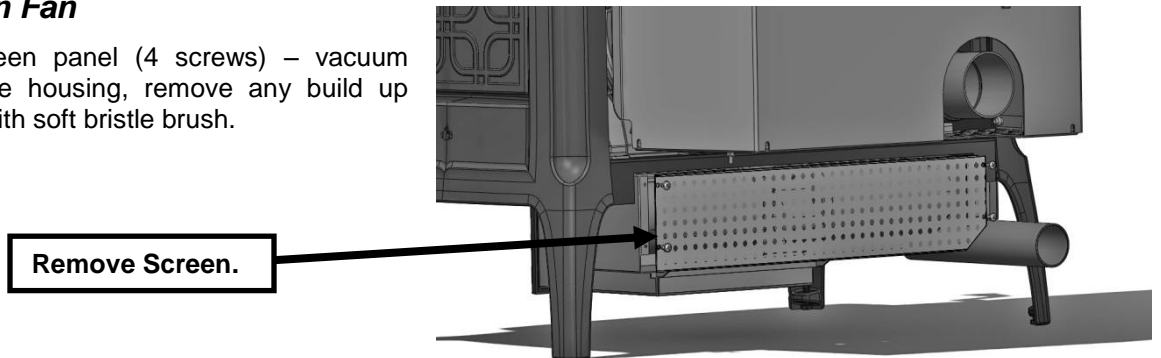

Clean Manifold

1. Remove both left and right heat exchanger access panels – vacuum inside the manifold.

Clean Exhaust Fan

2. With the access plates removed – remove any build up from exhaust fan blades with soft bristle brush.

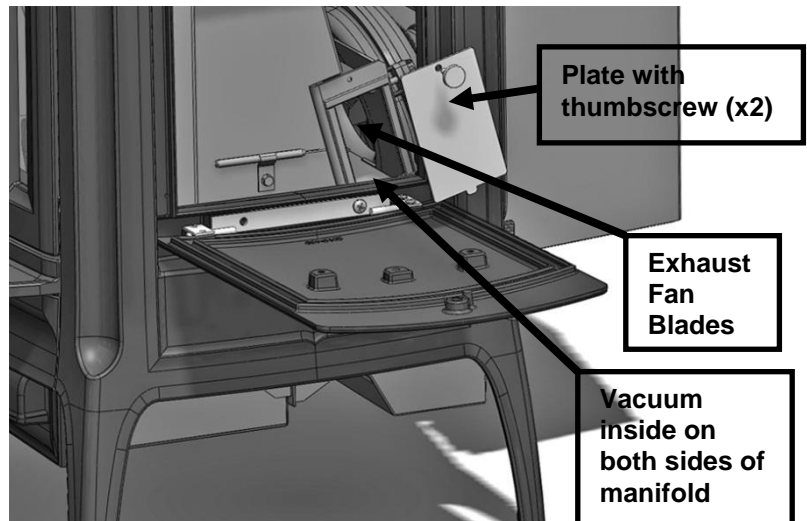

Inspect Gaskets

1. Use the Dollar bill test and check the door and ash pan gaskets for wear, replace as necessary.
 - a. Open the door, or ash pan, place a dollar bill over the gasket at various locations, close the door and pull the bill out.
 - b. If there is little or no resistance, adjust the latch tension or replace the gasket.

Inspect Venting

Soot and Flyash: Formation and Need for Removal - The products of combustion will contain small particles of flyash. The flyash will collect in the exhaust venting system and restrict the flow of the flue gases. Incomplete combustion, such as occurs during startup, shutdown, or incorrect operation of the room heater will lead to some soot formation which will collect in the exhaust venting system. The exhaust venting system should be inspected at least once every year to determine if cleaning is necessary.

1. Disassemble venting and check for ash and soot accumulation – clean as necessary.
2. Assemble flue connections - seal all connections after cleaning. Follow vent manufacturer's guidelines.

As Needed

External Cleaning

 **WARNING: DO NOT CLEAN THE UNIT WHEN HOT OR WHEN ANY SIGN OF COMBUSTION IS PRESENT.**

External Cleaning - The unit should receive regular cleaning on, under, and around the stove to prevent the buildup of dust and lint. Clean the exterior surfaces of the unit using soap, water, and a soft cloth. **Do not** use abrasive or chemical cleaners. Take care not to scratch the glass or enamel finish (if so equipped) when cleaning the unit. We do not recommend the use of chemical wax based cleaners or polishes due to the potential for discoloration of the castings or enamel when the residues of the cleaners or polishes are subject to heat. Excessive buildup of dust, spider webs, or room air contamination may cause odors when the stove is hot.

Glass Replacement Procedures

 **WARNING: DO NOT OPERATE THIS APPLIANCE WITH THE GLASS PANEL REMOVED, CRACKED, OR BROKEN. DO NOT SUBJECT THE DOOR TO ABUSE, SUCH AS STRIKING OR SLAMMING SHUT. ONLY A QUALIFIED SERVICE PERSON SHOULD REPLACE THE GLASS PANEL.**

Refer to Figure 1.

1. Follow the instructions included with the replacement glass kit.
2. Remove the door.
3. Remove the screws from the glass retainer (use penetrating oil if necessary) – lift the retainer off the glass. Set aside for reinstallation.
4. Carefully lift the damaged glass out of the door and discard.
5. Remove any remaining glass and old gasket material.
6. Clean the screw holes and place a small amount of anti-seize compound in each one.
7. Place the gasketed new glass onto the door. **Ensure sticker is on the exterior face of the glass.**
8. **Important! Center the glass** and ensure that the edges of the glass are parallel with the edges of the opening.
9. Check glass position again (centered, and parallel), then screw the glass retainer clips back on the door using a crisscross pattern. Tighten the screws no more than 1/8th of a turn after they seat. The glass will break at this point if not positioned correctly.

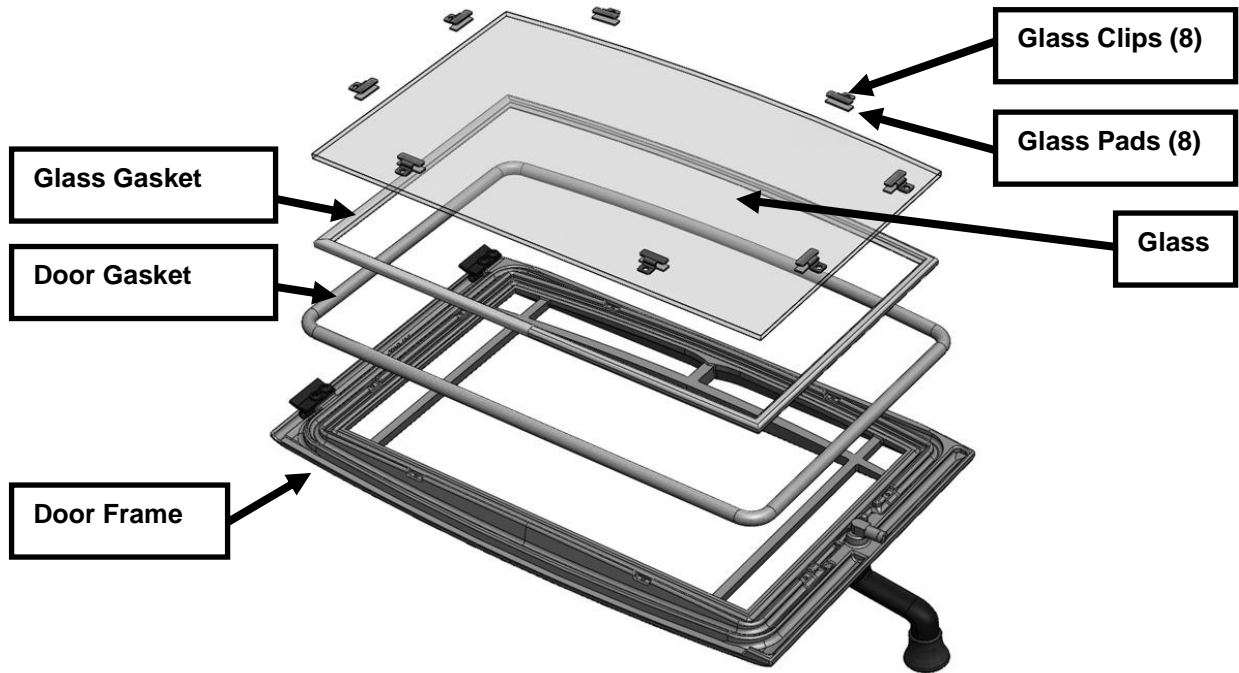

Figure 1: Front Door assembly

10. Apply a light film of anti-seize lubricant on the door's hinge pins if needed.
11. Install the door.
12. After 5 or 6 fires, check the glass retainer screws, and retighten if necessary.

Required Glass Kit: Part Number: 90-58901 (Glass with gasket applied). Use only 5mm Ceramic IR, or Neoceram IR glass. Contact your Hearthstone dealer.

Troubleshooting

Most errors and issues are due to a lack of required maintenance, or cleaning. Using the instructions on the following pages should resolve most issues. If an operation error is detected, the user interface flashes, and displays a message. If the message prompts the unit to shut down, a **>I/O<** notice will follow the text of the message. To acknowledge a message, press and hold the power button for approximately 5 seconds, if the process associated with the message is complete, the stove will return to OFF Mode. At this point, normal operation may begin again if all conditions are satisfied.

Display Messages:

Display	Problem	Possible Causes	Solution
No Pellets - (code F04)	Temperature in firebox unexpectedly dropped, or set point never reached	Pellet fuel level too low	Refill hopper
		Inferior, or wet pellets	Clean out hopper, and auger – refill with premium, dry pellets
		Auger jammed	Clean the auger. Follow the procedure in Maintenance section of this manual.
		Hopper door open	Close hopper door

Display	Problem	Possible Causes	Solution
No Ignition - (code F01)	Required pellet ignition temperature not achieved during startup – firebox temperature too low	Dirty Stove	Preform a Yearly Cleaning (see page 33)
		Inferior/wet pellets	Consult your Hearthstone dealer for a recommended pellet type and storage
		Auger clogged with fines	Clean auger
		Burn pot full of ash or clinkers	Clean burn pot
		Ash pan full and ashes contacting bottom of burn pot	Empty ash pan.
		Auger was completely empty and did not refill fast enough	Reset and start again. When the auger is empty, it may be necessary to add 1 cup of pellets to the burn pot prior to starting the unit.
		Front door, or ash pan open	Check both and verify they are closed completely, and sealing properly
		Hopper door is open	Close hopper door
		Blocked exhaust venting	Clean venting
		Restricted air intake, or outside air intake required.	Inspect ducting. Remove blockage. Install outside air intake
		Burn pot installed backwards	Install burn pot so ignitor hole is towards the rear of the stove
		Ignitor failed	Check wiring. Replace igniter
STb Initiated - (code F03)	Firebox/heat exchanger temperature too high	C-Fan (convection fan) setting above +5	Reset program. Do not adjust C-Fan setting.
		Convection fan not working	Service the unit.
		Convection fan clogged	Clean the convection fan. Follow the procedure in the Maintenance section of this manual.
		Top grill blocked	Remove any blockage from top of stove. Check for lint or hair on screen.
Flame Sensor – (code F06)	Temp sensor in firebox is malfunctioning	Flame sensor not working	Reset the unit using the power switch and contact your dealer if the problem persists.
Room Sensor – (code F07)	Communication between room sensor and stove interrupted	Room sensor unplugged	Check the rear room sensor connection at the rear of the stove or the connection on the inside of the room sensor.
		Sensor malfunction	Replace room sensor.
Too Little Air – (code F09)	Not enough air flow through firebox (monitored by sensors in inlet pipe)	The front door or ash pan open	Check both and verify that they are closed completely
		Inlet or exhaust venting blocked.	Inspect all venting. Verify there is no blockage. Clean Venting
		Excessive interior negative pressure	Install outside air inlet.
		Door gasket worn or missing	Check gasket using the dollar bill test outlined in this manual (see page 35). Replace gasket if necessary

Display	Problem	Possible Causes	Solution
		Exhaust blower clogged	Clean the blower. Follow the procedure in the Maintenance section of this manual.
		Dirty stove	Perform a Yearly Cleaning (see page 33)
		Poor air flow, or exhaust fan speed too slow	Replace 3" exhaust venting with 4"
			If everything checks, out and problem persists – increase exhaust fan speed
Cap Open	Hopper sensor not engaged. Note: The cap open error causes the auger to stop and will starve the stove for fuel if not addressed quickly.	Hopper open	Close hopper door
		Pellets on gasket seal	Clean off seal
		Hopper overfilled	Remove some pellets
		Hopper door not sitting correctly on hinges.	Check that the slots on the hopper door are fully engaged and the set screws are tight
		Sensor magnet dislodged.	Remount magnet on bottom of hopper door.
		Sensor malfunction	Replace sensor
Flue Gas Fan Faulty – (code F05)	The signal has stopped from the exhaust blower	Exhaust blower not working	Service the unit.
		Exhaust blower sensor wire disconnected	Service the unit.
		Exhaust blower clogged	Clean the exhaust blower. Follow procedure Maintenance section of this manual. Blades must move freely.

General Issues:

Problem	Possible Causes	Solution
Burn pot is overflowing.	Burn pot needs cleaning	Remove excess ashes, clinkers, and live coals from burn pot
	Ignition did not occur	Clean burn pot
		Ensure burn pot installed with ignitor hole towards rear
	Ignitor failure. Service the unit.	
	Dirty stove	Perform a Yearly Cleaning (see page 33)
	Stove feeding pellets without ignition	Turn off stove. Dump pellets into ash pan. Restart stove.
Burn pot clogs too quickly or pellets are partially burned (less than 24 hours of operation)	Poor quality or wet pellets	Consult your Hearthstone dealer for a recommended pellet type and storage
	Too much restriction in the venting	Clean intake and exhaust venting
		Increase the exhaust fan speed
	Replace 3" exhaust venting with 4"	
Excessive negative pressure in the house	Install an outside air intake.	

Problem	Possible Causes	Solution	
	Burn pot is not seated correctly	Burn pot must be in direct contact with the steel surface of firebox around the perimeter of the pot. Clean floor of firebox.	
	Ash pan too full and ashes contacting bottom of burn pot	Empty ash pan.	
	Exhaust blower clogged	Clean exhaust blower. Follow procedure in the Maintenance section of this manual.	
Fire has gone out	Room temperature satisfied (display reads STOP)	Normal operation	
	Stove in a cleaning cycle (display reads CLEAN)	Normal operation	
	No, or low fuel in hopper	Fill hopper with fuel	
	Too much restriction in venting	Clean intake and exhaust venting	
		Increase exhaust fan speed	
		Replace 3" exhaust venting with 4"	
	Hopper opened too long	Decrease fill time. When the hopper is open the auger does not turn which starves the fire of fuel	
Auger motor or exhaust fan failure	Service the unit.		
No power to the stove	Check circuit - supply power to the unit		
Visible, or the smell of smoke	Excessive negative pressure in the house is causing exhaust vent leak, or door gasket not sealing properly	Seal venting with 500°F RTV silicone.	
		Install outside air intake	
		Replace gasket	
	Power outage	Normal operation. Will dissipate when remaining pellets in hopper are consumed Contact your Hearthstone Dealer for battery back-up options	
Low heat output	Excessive soot on heat exchanger	Follow procedure in the Maintenance section of this manual.	
	Poor quality, or wet pellets	Consult your Hearthstone dealer for a recommended pellet type and storage	
	Dirty stove	Perform a Yearly Cleaning (see page 33)	
Display not working	Stove unplugged, or electrical circuit is off	Ensure stove is plugged in to an active circuit	
	Power outage	Contact your Hearthstone Dealer for battery back-up options	
	Connection between mother board and display not working	Check fuse on back of stove	
		Check wire connections between mother board and display	
Display malfunction	Replace display		

Replacement Parts & Optional Accessories List

PART NUMBER:	DESCRIPTION:	PART NUMBER:	DESCRIPTION:
CASTINGS:*		GASKETS:	
2010-915	ASH DOOR	3110-056	GASKET: ROPE, 1/4", BLK, AD
2010-997	HOPPER DOOR HANDLE	3110-057	GASKET: ROPE, 3/8", AD, NON-CORE
2310-300	TOP	3120-021	GASKET: GLASS CLIP
2310-305	HOPPER DOOR	3160-070	GASKET: TAPE 5/8" X 1/4"
2310-310	FRONT DOOR FRAME	3160-080	GASKET: TAPE, 3/4"x1/16", AD
2310-615	FRONT DOOR	3160-390	GASKET: FEEDER TUBE
2310-617	FRONT OR SIDE DOOR HANDLE	3160-391	GASKET: CONTROL BOARD
			GASKET: 3/8" X 1/8" FLAT KNIT BLK
2310-620	SIDE DOOR	3160-392	1/4" AD SP
2310-645	SIDE: WITH DOOR OPENING	3160-396	GASKET: MTR HOUSING KNOCKOUT
2310-650	FRONT GRILL	3160-397	GASKET: INLET TUBE
2310-655	ASH PAN DOOR HANDLE		
2310-660	ASH LIP	MISC:	
2910-000	BURN POT	3900-187	WOOD HANDLE
2910-005	BAFFLE: UPPER	4700-0795	MAGNET
2910-010	BAFFLE: LOWER	5090-080	SERVICE TOOL
		6400-40468	OWNER'S MANUAL
STEEL:		3120-220	UPPER BAFFLE CERAMIC HEATSHIELD
5090-011	PAN: ASH	3120-221	LOWER BAFFLE CERAMIC HEATSHIELD
5090-016	FRAME: OUTER ASH BOX	3200-101	SATIN BLACK HIGH TEMP PAINT
5090-069	SCREEN: OUTLET GRILL	7000-037	WIRE HARNESS
5090-070	LOUVER: CIRCULATION AIR	7211-951	CONVECTION FAN ASSY
5330-025	HINGE: HOPPER DOOR, LEFT	7211-967	EXHAUST FAN MOTOR
5330-026	HINGE: HOPPER DOOR, RIGHT	7211-970	AUGER MOTOR
5330-030	DOOR: SECONDARY HOPPER	7300-000	MOTHER BOARD
5330-035	AIR WASH,	7300-005	AIR FLOW SENSOR
5330-040	HOPPER: CABLE CHANNEL,	7300-010	CONTROL BOARD
5330-045	ROD: HEAT EXCHANGER CLEANING	7300-015	IGNITER ELEMENT
5360-050	HINGE: FRONT DOOR, WITH PIN	7300-020	HOPPER SAFETY SENSOR
5360-058	HINGE: SIDE DOOR	7300-025	TEMP SAFETY LIMIT SWITCH
5360-060	CLIP: SIDE DOOR HINGE	7300-030	FLAME SENSOR THERMOCOUPLE
5360-062	HINGE: FRONT DOOR		
5240-145	ASH PAN CATCH SPRING	KITS:	
5240-146	ASH PAN CATCH KNOB	90-56925	WIRED ROOM SENSOR KIT
5532-012	PALLET MOUNTING CLIP	90-58901	GLASS KIT
5909-061	AIR INLET PIPE	90-70900	HOPPER DOOR SUPPORT KIT
5909-070	HOUSING: EXHAUST FAN	90-73901	FRONT DOOR HANDLE KIT
		90-76900	LOWER BAFFLE KIT
		90-76901	UPPER BAFFLE KIT

* Part numbers: use 2010 for Matte, 2020 for Brown Majolica.

Manchester Pellet Stove Model 8330.

Manufactured and Warranted by:

Hearthstone Quality Home Heating Products, Inc.
317 Stafford Ave,
Morrisville, VT 05661
www.hearthstonestoves.com

Safety Label

CONTACT YOUR LOCAL BUILDING RESTRICTIONS AND INSTALLATION LISTED ROOM HEATER, PELLETIZED FUEL TYPE

Also Suitable for Mobile Home Installation Pursuant to (UM)84-HUD

Tested & Listed by / Testé et Certifié par:



OR FIRE OFFICIALS ABOUT INSPECTION IN YOUR AREA

Manufactured by / Manufacturé par:



317 Stafford Ave., Morrisville, VT 05661, USA

SERIAL #

NO SÉRIE
MODEL NAME: MANCHESTER 8330

TESTED TO: ASTM E1509-04,
ULC/ORD C1482-M1990,
ULC S627-00

REPORT #: 261-S-04b-2

Type of Fuel: For Use With Pelletized Wood Fuel Only

The use of other fuels may damage the unit.

Electrical Rating: 120 V, 4 A, 60 Hz

Input Rating: 15,300 to 51,000 BTU Typical

Note: Replace glass only with 5mm Ceramic IR or Neoceram IR glass.

Components required for residential and mobile home installation: Listed 3" or 4" Pellet Vent.

DANGER: Risk of electrical shock. Disconnect power before servicing unit. Do not route power cord beneath heater.

WARNING: Do not obstruct the space beneath the heater.

NOTE: Do not open the ash pan or front door until the stove has cooled completely.

"PREVENT HOUSE FIRES"
Install and use only in accordance with manufacturer's installation instructions and your local building codes.

CAUTION: Special methods are required when passing chimney through a wall or ceiling. Follow the pipe manufacturer's instructions and local building codes for the clearance to combustibles required for the installation of the vent pipe being used. Do not pass chimney connector through a combustible surface. Do not connect this unit to a chimney flue serving another appliance. If not using an outside air inlet for combustion a source of fresh air must be provided to the room.

Room Heater, Pellet Fuel-Burning Type, Also For Use In Mobile Homes.

WARNING: (MOBILE HOME)

An outside air inlet must be provided for combustion and be unrestricted while unit is in use.

Clearance to Combustible Materials

Refer to the Manual for additional clearance and operation information.

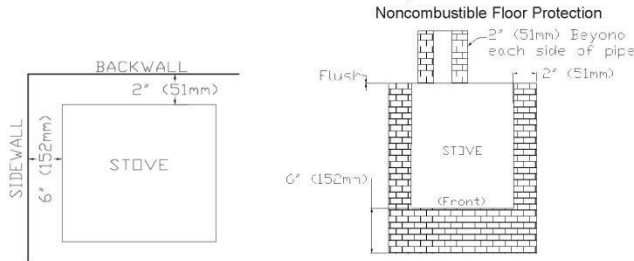

CAUTION

- Hot while in operation.
 - Do not touch, keep children, clothing, and furniture away.
 - Contact may cause skin burns.
- See name plate and instructions.

DO NOT OVER-FIRE. IF HEATER OR CHIMNEY CONNECTOR GLOWS, YOU ARE OVER-FIRING. INSPECT AND CLEAN CHIMNEY AND CONNECTOR FREQUENTLY. UNDER CERTAIN CONDITIONS OF USE, FLY ASH BUILDUP MAY OCCUR RAPIDLY. MOVING PARTS MAY CAUSE INJURY.

CAUTION: OPERATE THIS UNIT ONLY WITH THE FUEL HOPPER LID CLOSED. FAILURE TO DO SO MAY RESULT IN EMISSIONS OF PRODUCTS OF COMBUSTION FROM THE HOPPER UNDER CERTAIN CONDITIONS. MAINTAIN HOPPER SEAL IN GOOD CONDITION. DO NOT OVERFILL THE HOPPER.

WARNING: RISK OF SMOKE AND FLAME SPILLAGE, KEEP VIEWING AND ASH REMOVAL DOORS TIGHTLY CLOSED DURING OPERATION.

U.S. ENVIRONMENTAL PROTECTION AGENCY
Certified to comply with July 1990 particulate emission standards.

DATE OF MANUFACTURE / DATE DE FABRICATION

2011 2012 2013 JAN FEB MAR APR MAY JUN JUL AUG SEP OCT NOV DEC

DO NOT REMOVE OR COVER THIS LABEL 3300-215 REV B

Limited Warranty

These warranties give you specific legal rights. You may also have other rights which vary from State to State.

Hearthstone Quality Home Heating Products, Inc. (Hearthstone) warrants to the original retail purchaser only (the "Original Purchaser") the new appliance manufactured by Hearthstone, purchased by the Original Purchaser and installed by an authorized Hearthstone dealer or their designated representative against any of the occurrences listed in this document that result from defects in material or workmanship. This warranty is not transferrable. All obligations of Hearthstone under this document commence on the date of the Original Invoice (the "Purchase Date"). The term "Limited Lifetime" is defined as 10 years from the beginning of warranty coverage.

Hearthstone appliances are designed to be operated only with the fuels listed in your owner's manual.

Warranty Period	Wood	Gas	Pellet	Covered Components
Limited Lifetime	X	X	X	Stone
	X	X	X	Cast iron not listed elsewhere
	X			Clean burning air supply system*
5 Year	X	X	X	Door handles and latches
	X	X	X	Steel Components and Firebox
		X		Burner and logs
3 Year			X	Burn Pot and Baffles
2 Year	X	X	X	Appliance Electrical and Gas Components
	X	X		Refractory, Vermiculite Panels, Baffles
1 Year	X	X	X	Enamel finish against peeling or fading
	X	X	X	Accessories
	X	X	X	Glass
	X			Ash Grate
	X	X	X	All components not listed elsewhere

Any parts repaired or replaced during the limited warranty period will be warranted under the terms of the limited warranty for a period not to exceed the remaining term of the original limited warranty or one year, whichever is longer.

Parts: Hearthstone will replace through an authorized dealer, defective parts covered by the foregoing warranty at no charge.

Labor: Within the first (1st) year after the Purchase Date, Hearthstone will pay for warranty labor performed by an authorized Dealer at Hearthstone's published labor rates in effect at the time the labor is performed only if the appliance is installed by an authorized dealer or their designated representative. Otherwise or thereafter, the Original Purchaser is responsible for the cost of labor.

Shipping cost for parts: Within the first ninety (90) days after the Purchase Date, Hearthstone will pay for the shipping of appliance parts covered by any of the foregoing warranties to and from Hearthstone or an authorized Dealer, as the case may be. Thereafter, the Original Purchaser is responsible for all shipping costs related to shipping appliance parts to and from Hearthstone or an authorized Dealer, as the case may be.

Shipping cost for the appliance: Within the first (1st) year after the Purchase Date, if the Original Purchaser is instructed to return the appliance to Hearthstone or an authorized Dealer for repair, Hearthstone will pay fifty percent (50%) and the Original Purchaser will pay fifty percent (50%) of the shipping costs related to shipping the appliance to and from Hearthstone or an authorized Dealer, as the case may be. Thereafter, the Original Purchaser is responsible for one hundred percent (100%) of all of the shipping costs related to shipping the

appliance to and from Hearthstone or an authorized Dealer, as the case may be. Notwithstanding any other provision of this document, in no event will Hearthstone pay for any Dealer fees or other fees for pick up or delivery of the appliance returned for repair; the Original Purchaser shall be responsible for any such fees.

EXCLUSIONS & CONDITIONS

The warranties contained in this document do not cover, nor is Hearthstone responsible for:

1. Damages resulting from:
 - a. Failure to install, operate, or maintain the appliance in accordance with the owner's manual, operating instructions, installation instructions, or safety rating label provided with the appliance.
 - b. Over-firing the appliance. Over-firing can be identified by, but not limited to, warped cast iron or steel, rust colored cast iron, bubbling, cracking and discoloration of steel or enamel finishes.
 - c. Failure to install the appliance in accordance with all national or local building codes.
 - d. Shipping or improper handling.
 - e. Improper operation, abuse, misuse, continued operation with damaged, corroded, or failed components, accident, or improper/incorrect service or repairs.
 - f. Environmental conditions, inadequate ventilation, negative pressure, or improper drafting caused by tightly sealed constructions, insufficient make-up air supply, or air handling devices such as exhaust fans, forced air furnaces, or other such causes.
 - g. Damage caused by direct exposure to water.
 - h. Use of fuels other than those specified in the owner's manual.
 - i. Installation or use of components not supplied with the appliance, or any other components not expressly authorized and approved by Hearthstone.
 - j. Modifications of the appliance not expressly authorized and approved by Hearthstone in writing
 - k. Interruptions or fluctuations of electrical power supplied to the appliance.
2. All stones are warranted against cracking or breakage due to thermal stress, excluding surface and hairline cracks and scratches that do not affect the operation, or safety of the appliance.
3. Repair or replacement of wear parts. Such parts that are subject to normal wear and tear during the warranty period such as paint, gaskets, baffles, refractory materials, ash grates, and glass.
4. Damage resulting from installation, modification, alteration, repair or service of the appliance by any party other than an authorized Hearthstone dealer (a "Dealer") or their designated representative, or Hearthstone.
5. Damage due to water or condensation due to installation of the appliance in a high moisture area.
6. Damage due to installation of the appliance in an atmosphere contaminated by damaging chemicals, including but not limited to chlorine, fluorine or salts.
7. Scratches on glass, enameled surfaces or stones due to mechanical abrasion.
8. Noise caused by expansion or contraction caused by the heating and cooling of the appliance.
9. Odors caused by the heating of the appliance, or surrounding materials
10. Consequential damage caused by leaking of condensate during startup
11. A defect in any part of the appliance if the Original Purchaser fails to comply with Hearthstone's or a Dealer's request to ship the part or the appliance to Hearthstone or a Dealer, as the case may be.
12. Replacement stones and enameled parts are taken from current stock, and may not match originals in color, grain, or pattern. Hearthstone will supply replacement parts for discontinued parts in finishes or colors as available, or at their discretion.
13. Hearthstone's obligation under this warranty does not extend to the appliance's ability to heat the desired space. Information is provided to assist the customer and the dealer in selecting the appropriate appliance for the application. Consideration must be given to appliance location and configuration, environmental conditions, insulation and air tightness of the structure.

THE WARRANTIES CONTAINED IN THIS DOCUMENT ARE EXCLUSIVE AND ARE GIVEN BY HEARTHSTONE AND ACCEPTED BY THE ORIGINAL PURCHASER IN LIEU OF ALL OTHER EXPRESS WARRANTIES AND ANY OBLIGATIONS, LIABILITIES, RIGHTS, CLAIMS, OR REMEDIES IN CONTRACT OR TORT, WHETHER OR NOT ARISING FROM HEARTHSTONE'S NEGLIGENCE, ACTUAL OR IMPUTED. ALL IMPLIED WARRANTIES, INCLUDING THE WARRANTIES OF MERCHANTABILITY AND FITNESS FOR A PARTICULAR PURPOSE, ARE GIVEN ONLY TO THE EXTENT REQUIRED BY FEDERAL OR STATE LAW. EXCEPT AS OTHERWISE REQUIRED BY STATE LAW, UPON THE EXPIRATION OF THE EXPRESS LIMITED WARRANTIES CONTAINED HEREIN, NO IMPLIED WARRANTIES, INCLUDING THE IMPLIED WARRANTIES OF MERCHANTABILITY OR FITNESS FOR A PARTICULAR PURPOSE, SHALL APPLY TO

THE SUBJECT APPLIANCE. SOME STATES DO NOT ALLOW LIMITATIONS ON HOW LONG AN IMPLIED WARRANTY LASTS, SO THE ABOVE LIMITATION MAY NOT APPLY TO YOU.

THE WARRANTIES CONTAINED IN THIS DOCUMENT EXTEND ONLY TO THE ORIGINAL PURCHASER OF THE APPLIANCE WARRANTED HEREUNDER. THEY ARE NOT TRANSFERRABLE AND DO NOT EXTEND TO ANY SUBSEQUENT OWNERS.

UNDER NO CIRCUMSTANCES SHALL HEARTHSTONE BE LIABLE TO THE ORIGINAL PURCHASER OR ANY OTHER PERSON FOR ANY INCIDENTAL OR CONSEQUENTIAL DAMAGES, INCLUDING BUT NOT LIMITED TO DAMAGE TO PROPERTY OR PERSONAL INJURIES, WHETHER ARISING OUT OF LOSS OF USE, BREACH OF WARRANTY, TORT, OR OTHERWISE, EVEN IF HEARTHSTONE HAS BEEN APPRAISED OF THE POSSIBILITY OF SUCH DAMAGES. SOME STATES DO NOT ALLOW THE EXCLUSION OR LIMITATION OF INCIDENTAL OR CONSEQUENTIAL DAMAGES, SO THE ABOVE LIMITATION OR EXCLUSION MAY NOT APPLY TO YOU.

QUALIFYING FOR WARRANTY COVERAGE

To obtain performance of any obligation under this document, the Original Purchaser must, within the applicable warranty time period, contact their original Hearthstone dealer, or the current responsible local Hearthstone dealer, for instructions regarding the return of defective parts for repair, the return of the appliance for repair, or to schedule a Dealer service call. The Original Purchaser should refer to the Dealer Network search engine contained on Hearthstone's Web site (www.hearthstonestoves.com) if the original dealer is not available, to find a Hearthstone dealer nearest to the Original Purchaser's location.

REMEDY

The remedy for any breach of the foregoing warranties will consist of repair or replacement, at Hearthstone's option, of any covered defect in the appliance. When the Original Purchaser contacts a Hearthstone Dealer, the Dealer on behalf of Hearthstone, as the case may be, will instruct the Original Purchaser to either return the defective part, or the entire appliance (if requested), to the Dealer or Hearthstone or allow a Dealer to make a service call at the place where the appliance is located. Hearthstone may require that a digital picture be provided to support the claim. Notwithstanding any other provision of this document, the Original Purchaser shall pay for any fees and service charges related to a Dealer's service call or the shipping charges associated with the return.

WARRANTY REGISTRATION

The Original Purchaser can complete their warranty registration on our website at www.hearthstonestoves.com.
Hearthstone's physical address is:

Hearthstone Quality Home Heating Products, Inc.
Warranty Department
317 Stafford Avenue
Morrisville, VT 05661

NOTE: ON-LINE REGISTRATION IS *NOT REQUIRED* AS A CONDITION OF WARRANTY COVERAGE OR HEARTHSTONE'S PERFORMANCE.

Customized Set Up Data: