

Technical Data Sheet

Green Mountain 8640, 8660, and 8680 Latch Replacement Instructions *Assembly 96-73400*

INCLUDED IN KIT:

- (1) 4500-2976 - Set Screw
- (3) 4700-0790 - Brass Spacer
- (1) 5000-565 - Steel Crank Handle
- (1) 5640-022 - Latch
- (1) 4600-0800 - Washer
- (1) 5240-138 - Tension Spring
- (1) 5640-020 - Striker Plate

TOOLS REQUIRED:

- Pair of Work Gloves
- 5/32" Allen Wrench
- Pliers or Vise Grips
- Phillips Screwdriver
- Flashlight

BEFORE YOU BEGIN: *Always work on a cool stove.* Read the instructions thoroughly before starting the repair. Identify all parts included in the kit. Report any shortages to your dealer.

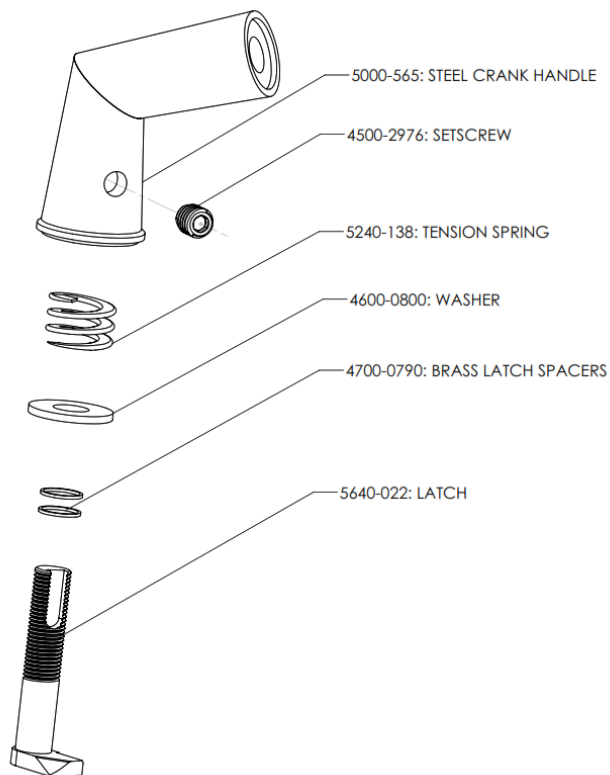

Figure 1: Latch Components

- (1) Using screwdriver, turn out the screw that holds the wooden handle to the latch assembly. Keep the wooden handle with the screw to install on the replacement latch.
- (2) Locate the set screw on the outer surface of the steel crank. Using the 5/32" allen wrench, completely turn out the setscrew holding the original latch to the outer steel crank. While holding the latch with the pliers, rotate the outer steel crank until it disengages from the threaded portion of the latch.
- (3) Separate the latch and crank. Discard all of the original latch components (except for the wooden handle that will be reused).
- (4) Place the brass washers onto the latch shaft.
- (5) Push the latch shaft through the door. Place the large black washer onto the latch on the outside of the door. It will be flush to the surface of the outer door. Place the tension spring over the latch on the outside.
- (6) Thread the steel crank onto the latch shaft. Continue to turn until it is flush to the surface of the door. Now turn it back until it is approximately 1/8" from the surface of the door.
- (7) Turn the cast iron crank until you can see the grooved-out notch in the edge of the latch shaft (a flashlight may be helpful here). Once the two pieces are lined up in this manner, turn in the new setscrew. Use the allen wrench to tighten the setscrew into the grooved notch in the latch.



Figure 2: Latch shaft showing detail of groove of the edge where the set screw will lock into place.

- (8) Using the slotted screwdriver, attach the original wooden handle onto the new latch assembly.
Note: If the latch requires adjustment, you will need to separate it again. To draw it tighter, remove a shim washer from the inside. Complete step 9 before confirming fit.
- (9) Using the Philips screwdriver, remove the screws securing the old latch striker to the cast iron. Reserve screws and use to install new striker.

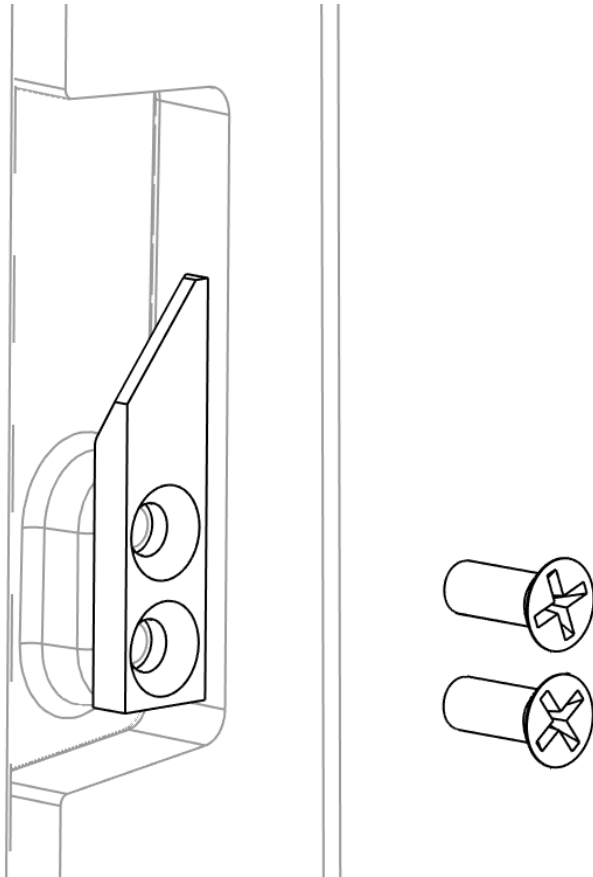

Figure 3: Latch striker and screws